

NF-16-1ph-MHU

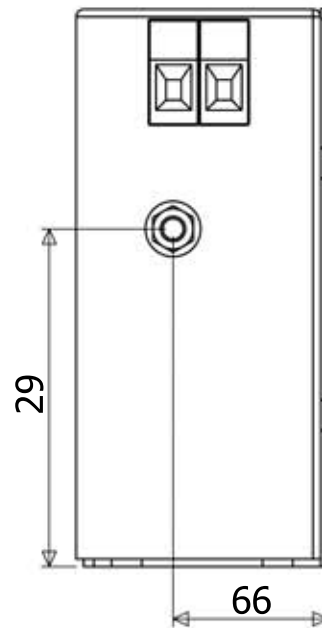
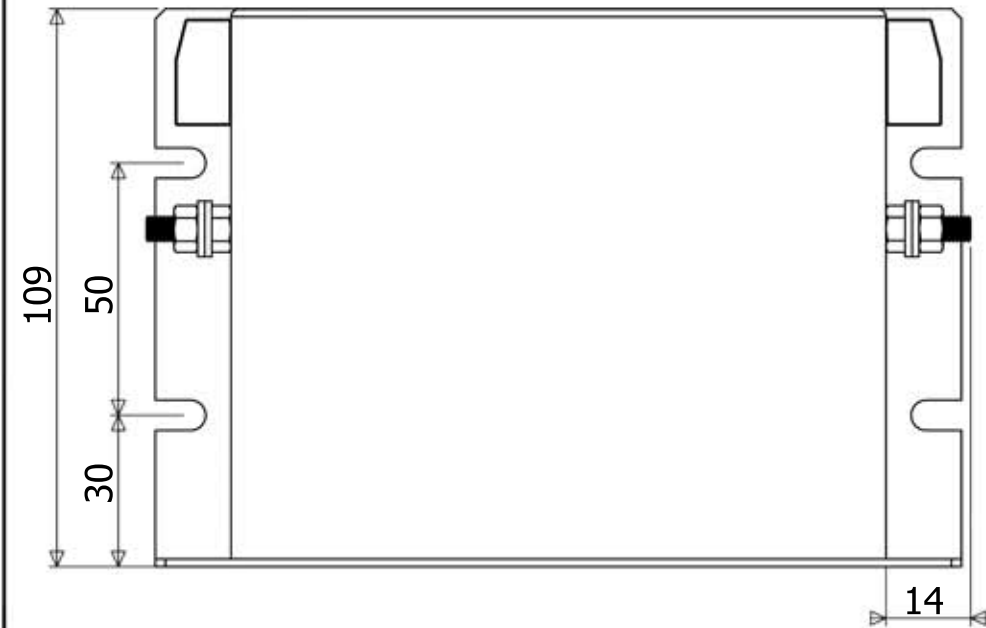
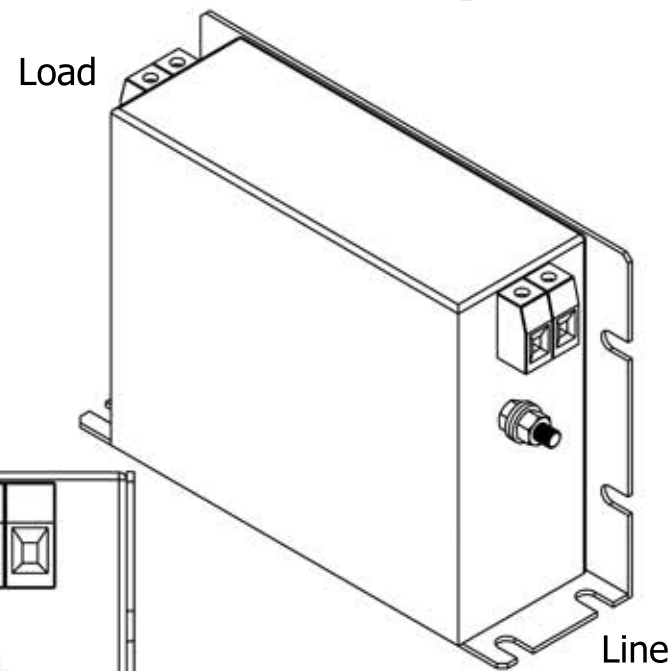
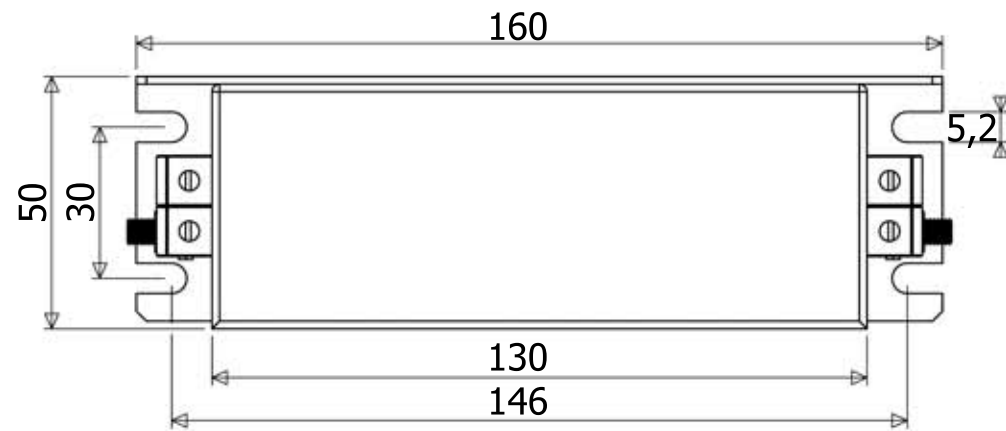

Alle mål er angivet i mm. Tolerance $\pm 0,3$ mm.
Der tages forbehold for ændringer i målene.

ELSAG
Sønderskovvej 9, Nordenskov
6800 Varde

E-mail: kontakt@elsag.dk
Telefon 75 29 87 90