

Operating instructions

RYMASKON® 1000 Interface

Interface for controlling temperature, fans,
light and sun protection (2 zones)

Room control unit with colour TFT display and capacitive keys (touch keys),
with Modbus connection or (Wireless)



TABLE OF CONTENTS

Important notes, safety notes	003
Installation and commissioning	003
Modbus installation	004
W-Modbus installation	005
UNIT DATA	
Core features, introduction	006
Technical data	007
Dimensional drawing	008
Basic models, connection diagrams	009
Number keys	010
Type table	011
CONFIGURATION	
1.0 Configuration, general information	012
1.1 Configuration menu (display)	012
1.2 Configuration software (PC)	014
1.3 Configuration register (higher-level system)	014
1.4 W-Modbus	015
1.5 CuRA (Customised Register Assignment)	015
1.6 Setting the time (time/date)	015
USER INTERFACE	
Icons and abbreviations	016
2.0 User interface, general information	017
2.1 HMI layout (Human Machine Interface)	017
2.2 Screen saver	018
2.3 Cleaning mode (key lock for 20 s)	019
2.4 Key lock (child lock)	019
TEMPERATURE	
3.0 Temp menu, general information (setpoint temperature adjustment)	020
3.1 Current temperature	021
3.2 Setpoint temperature	021
3.3 Operating mode	021
3.4 Fan display	021
FAN	
4.0 Fan menu, general information (fan adjustment)	022
4.1 Number of fan steps	023
4.2 Fan operating status	023
4.3 Fan label	023
4.4 Fan level	023
SENSORS	
5.0 Sensor menu, general information (sensor display).....	024
5.1 Sensor menu configuration	025
5.2 Calibrating the internal CO2 and VOC sensors	025
PRESENCE	
6.0 Presence menu, general information (presence change)	026
6.1 Presence status	027
DIGITAL INPUTS & HEADER ICONS	
7.0 Inputs, general information	028
7.1 Inputs as presence contact	028
7.2 Inputs as contact for header icons	028
7.3 Header Icon/Status	029
TOUCH KEY EXTENSION	
8.0 Touch key extension, general information	030
8.1 Sun Protect menu (sun protection adjustment)	032
8.2 Light menu (light adjustment)	034

IMPORTANT NOTES

Only the valid edition of our conditions and the valid "General Conditions for the Supply of Products and Services of the Electrical and Electronics Industry" (ZVEI conditions) and the supplementary clause "Extended Retention of Title" apply as the General Terms and Conditions regulating this purchase.

The following points must also be complied with:

- These instructions must be read before installation and commissioning, and all of the specifications that they contain must be complied with!
- The units must only be connected to an extra-low safety voltage in a de-energised condition. To avoid damaging the unit and prevent faults (e.g. due to voltage induction), use shielded cables, avoid laying them parallel to power cables and observe the EMC directives.
- This unit must only be used for its intended purpose, whereby the applicable VDE safety regulations and all regulations issued by the regional and national regulatory authorities, TÜV and local energy providers must be complied with. The purchaser must ensure that the relevant building and safety regulations are complied with, and must avoid hazards of all kinds.
- No warranty or liability claims whatsoever will be accepted for defects and damage arising from improper use of this unit.
- The warranty and liability excludes consequential damage caused by a fault in this unit.
- The units must only be installed and commissioned by qualified personnel.
- Only the technical data and connecting conditions specified by the installation and operating instructions which are included in the scope of delivery of the unit apply. Deviations from the depictions contained in the catalogue are not additionally listed, and are possible as a result of technical progress and the continuous improvement of our products.
- Any alterations made to the unit by the user will void the warranty.
- This unit must not be installed close to sources of heat (e.g. radiators) or their heat flow. Avoid direct solar irradiation or heat radiation from similar sources (powerful lamps, halogen spotlights).
- Operating this unit close to other units that do not comply with EMC directives may influence functionality.
- This unit must not be used for monitoring purposes which serve to protect persons against hazards or injury, as an Emergency Stop switch on systems or machinery, or for any other similar safety-related purposes.
- The housing dimensions and the dimensions of accessories may differ slightly from the specifications of these instructions.
- Changes to these documents are not permitted.
- In cases of complaint, we will only accept complete units returned in their original packaging.



Safety notes

- Units must only be connected to a safety extra-low voltage and in a de-energised state.
- If power supplies with an output power greater than 15 W are used, additional safety measures (circuit breakers) must be implemented to limit the power output in the event of a fault.
- Commissioning is mandatory and may only be performed by qualified personnel!

INSTALLATION AND COMMISSIONING

Commissioning is mandatory and may only be performed by qualified personnel!
Please read these instructions prior to installation and commissioning,
and comply with the specifications that they contain!

Installation must take place while observing all relevant regulations and standards (e.g. such as welding regulations, etc.) applicable at the place where the measurement is taken. It is very important to comply with the following:

- VDE / VDI technical temperature measurements, directives, measurement set-ups for temperature measurements
- EMC directives
- It is imperative to avoid parallel routing of power cables
- We recommend the use of shielded cables with the shielding attached to the DDC / SPS at one side.

Before installing, make sure that the existing technical parameters of the measuring instrument comply with the actual conditions at the place of utilisation, especially:

- Measuring range
- Maximum permissible temperature and humidity
- Protection type and protection class
- Oscillation, vibrations and impacts must be avoided (< 0,5 g)

INSTALLATION

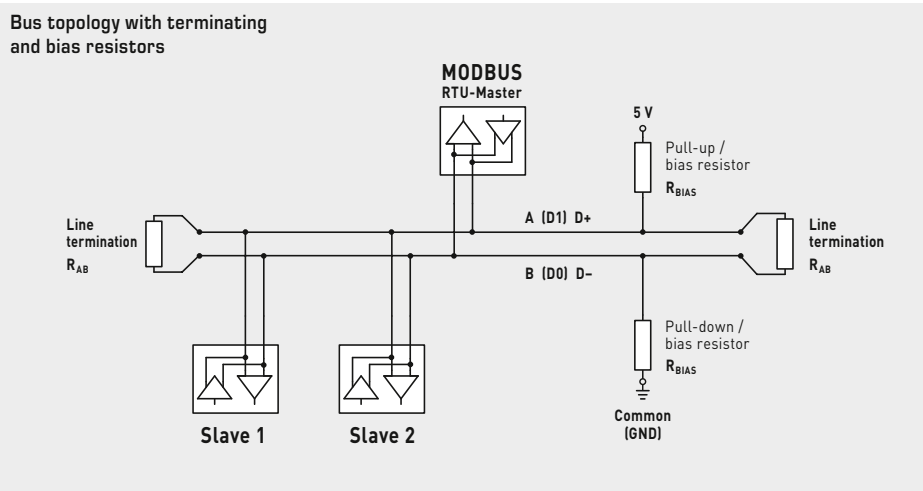
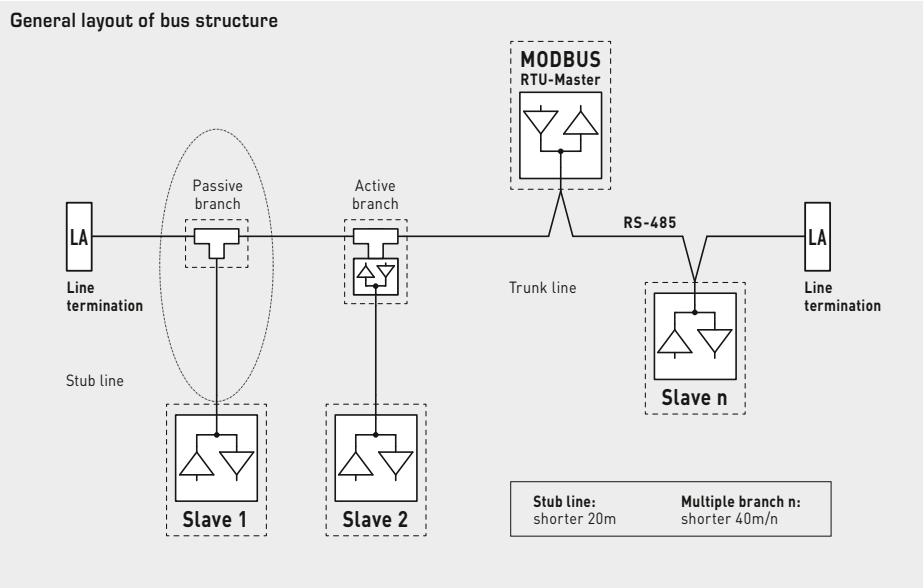

Terminating resistors may only be installed at the ends of the bus line.

If necessary, the **LA-Modbus** (separate accessory) can be used as a terminating resistor for **RYMASKON**. No more than two line terminators are permitted in networks without repeaters.

The **bias resistors** for bus level definition in the resting state are usually activated at the Modbus master/repeater.

The maximum **number of subscribers** per Modbus segment is 32 units.

With a greater number of subscribers, the bus must be subdivided into several segments separated by repeaters. The subscriber address can be set from 1 to 247.

A cable with a twisted-pair data line/power supply line and copper shielding braid must be used for the **bus line**. The line capacitance must be less than 100 pF/m (e.g. Profibus cable).

INSTALLATION

W-Modbus 

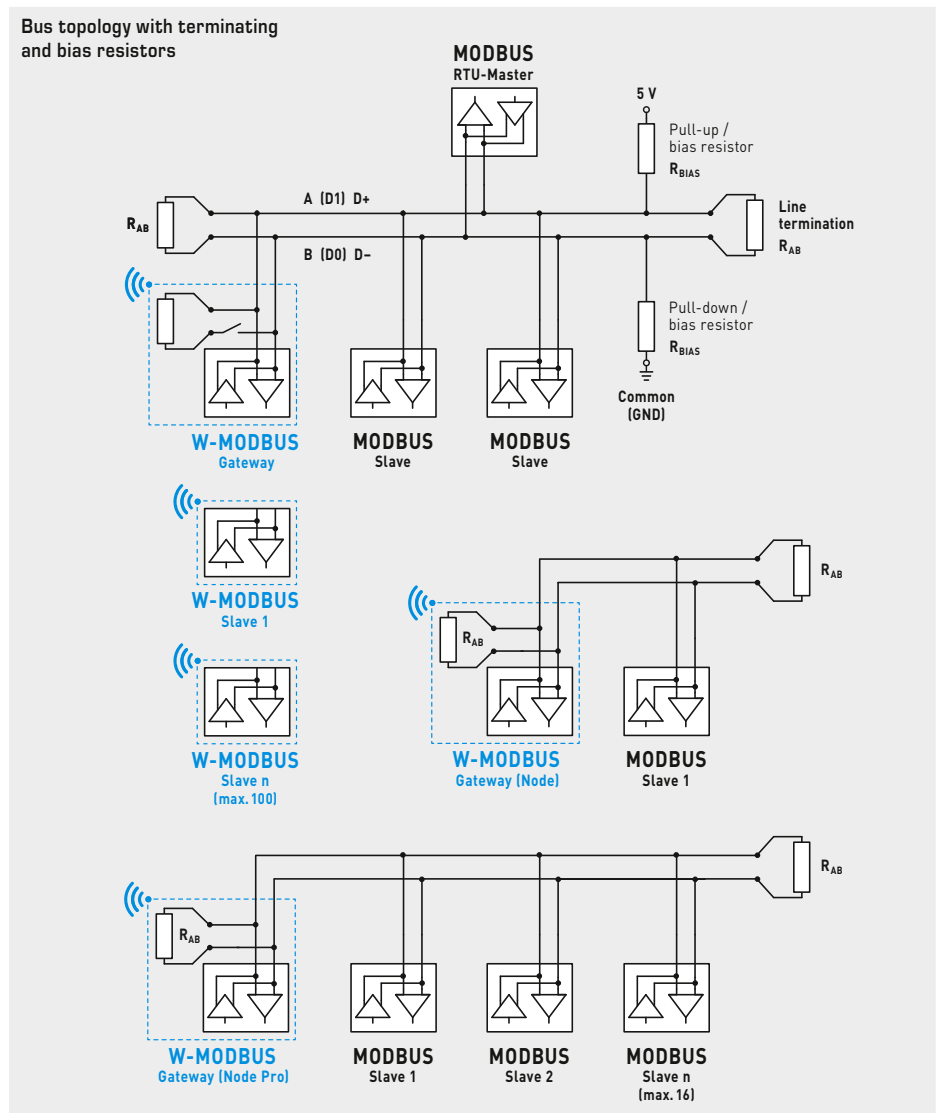

The **W-Modbus protocol** is based on the 2.4 GHz ISM radio band and employs patented frequency hopping technology to maximise reliability and resistance to interference. This means that reliable radio transmission can also be ensured in industrial environments.

In the **W-Modbus network**, up to 100 nodes can communicate with each other over a long distance (up to 500 m in an open field) using one gateway. A standardised W-Modbus module ensures compatibility with all W-Modbus units.

The **W-Modbus sensors** only need to be supplied with power. Only the slave address and the transmission parameters (baud rate and parity) are set automatically. No terminating resistor is necessary. The sensor is then paired with a gateway.

The **W-Modbus-gateway** serves as a transition between wired Modbus and radio-based W-Modbus. Even mixed configurations of wired and radio-based Modbus units can be easily integrated into existing network topologies via the W-Modbus gateway.

S+S Regeltechnik GmbH hereby declares that the radio equipment type **RYMASKON® 1000 Interface W-Modbus (WMOD)** complies with the Directive 2014/53/EU. The full text of the EU Declaration of Conformity can be found at the following Internet address: www.spluss.de/RYM13011W210000/

KEY FEATURES

Basic models
(see type table)



- 24 V AC/DC voltage supply
- **Modbus** connection or wireless **W-Modbus**
- 2.0" TFT **display** (320 x 240 x 3 RGB pixels), with LED backlighting, high contrast, 85° viewing angle
- Capacitive keys (**touch keys**)
(optional extension, see number key pos. 14-15)
- **Housing** Iduna 3 (112 x 89.5 x 24 mm), white and black colours, for wall-mounting on in-wall flush boxes or on-wall, quick and easy installation via push-in terminals
- Integrated temperature and humidity sensor (basic equipment)
(additional sensors optional: CO₂, VOC)
- **Regulation** of heating, cooling, fan via Modbus/W-Modbus
- **Control** of temperature, fan
(sun protection and light with dimming function available as an option)
- Power-saving and environmentally friendly thanks to **features** such as brightness adjustment, stand-by, wake-up, etc.
- **CuRA** (Customized Register Assignment)
Assignment of individual register addresses for each data point

DESCRIPTION

Introduction

The room control units of the **RYMASKON® 1000 / 2000 / 3000** series are designed for control (up to 5 climate zones) in residential, hotel and office rooms and individually regulate the heating, cooling and fan levels of the internal rooms. The controller variants can be operated as stand-alone units thanks to the integrated control functions PI, PWM or 2-/3-point control. The product family is characterised by its elegant design, intuitive operation and the many possible combinations of the individual components.

The **RYMASKON® 1000** room control units (Interface) are used for controlling temperature, fans, sun protection (Venetian blinds, shutters) or light (with dimming function). The room control units make the setpoints available to the BMS either via conventionally wired Modbus or via the wireless, radio-based W-Modbus. Visual indication takes place on a 2" TFT **display**, where as the unit is controlled via capacitive keys (**touch keys**).

In addition to the integrated temperature and humidity sensor, **sensors** for CO₂ and VOC are available as an option. An input for a passive temperature sensor (NTC10K) and an input for a potential-free contact are additionally available. This allows a window contact or a condensation control switch to be connected, for example. This provides all options for air-conditioning of the rooms according to individual requirements.

All unit types are available in the contemporary **housing** Iduna 3 (112 x 89.5 x 24 mm) in white or black colour. Wall-mounting is performed on standard in-wall flush boxes or on-wall.

DESCRIPTION

Technical data
 (Rev. V33)

TECHNICAL DATA	(Basic models)
Unit type:	Room control units (Interface)
Functions:	Temperature, fan, sun protection and light (see type table)
System of units:	SI (default) or imperial (can be changed in the Modbus register)
Data points:	Temperature [°C] [°F], relative humidity [%RH], air quality (VOC) [%] [ppb], carbon dioxide (CO ₂) [ppm], setpoint (temperature, fan, presence)
Power consumption:	typically < 3 W at 24 V DC; typically < 4.5 VA at 24 V AC
Voltage supply:	24 V AC/DC (± 10%)
Communication:	Modbus (RTU cable), Slave, address range 1...247, max. 32 units, RS 485 interface, galvanically isolated , 9600 / 19200 / 38400 / 57500 bauds, 8N1, even / odd parity, 1 / 2 stop bits or W-Modbus (Wireless Modbus, AES-128 encrypted), Frequency 2.4 GHz ISM, Transmission power 100 mW , Range max. 500 m (open field) / approx. 50-70 m (inside buildings), Slave, address range 1...247, max. 100 units on one gateway, BMS connection is radio-based via W-Modbus gateway
Display:	TFT display , 2" (41 x 30 mm), 320 x 240 x 3 pixels (RGB), LED backlighting, viewing angle ± 85°
Operating elements:	Capacitive keys (up to 10 keys, depending on type) for setting the target temperature, fan stages, presence message, sensor values, and for operating sun protection and light
Inputs:	1 NTC10K (configurable as a digital input) 1 digital input for potential-free switches
Outputs:	Modbus or W-Modbus
Electrical connection:	0.2 - 1.5 mm ² , using push-in terminals
Housing:	plastic, flame retardant (UL 94 V-0), PC/ABS material, colour white (similar to RAL 9016) or black (similar to RAL 9004)
Housing dimensions:	112 x 89.5 x 24 mm (W x H x D) (Iduna 3) in-wall: + 23 mm (D), sensor protection: + 22 mm (H)
Mounting:	wall-mounting on in-wall flush box, Ø 55 mm or on-wall
Ambient temperature:	0...+50°C (operation); -30...+70°C (storage)
Permitted humidity:	0...90%RH (non-precipitating air)
Protection type:	IP 30 (according to EN 60529)
Standards:	CE conformity according to EMC Directive 2014/30/EU (Modbus) or Radio Equipment Directive 2014/53/EU (W-Modbus)
TEMPERATURE	(basic equipment)
Sensor:	digital temperature sensor, low hysteresis, high long-term stability
Measuring range:	0...+50 °C / +32...+122 °F
Accuracy:	typically ± 0,5 K / ± 0.9 °F at +25 °C / +77 °F
HUMIDITY	(basic equipment)
Sensor:	digital humidity sensor, low hysteresis, high long-term stability
Measuring range:	0...100% RH
Accuracy:	typically ± 2.0 % (20...80% RH) at +25 °C / +77 °F, otherwise ± 3.0 %
CARBON DIOXIDE (CO₂)	(optional)
Sensor:	digital photoacoustic NDIR-CO ₂ sensor (non-dispersive infra-red technology), with automatic calibration and high long-term stability
Measuring range:	0...2000 ppm
Accuracy:	typically ± 50 ppm, ± 3 % of the measured value at +25 °C / +77 °F
AIR QUALITY (VOC)	(optional)
Sensor:	digital metal oxide (MOX) based VOC sensor
Measuring range:	0...100% (corresponds to IAQ Index 1...500 or 0...2383 ppb ethanol equivalent – non-linear)
Accuracy:	< ± 15 %
Service life:	> 10 years (if used as intended, depending on type and duration of VOC exposure)

DIMENSIONAL DRAWING

In-wall version
 housing **Iduna 3 (UP)**
 [mm]

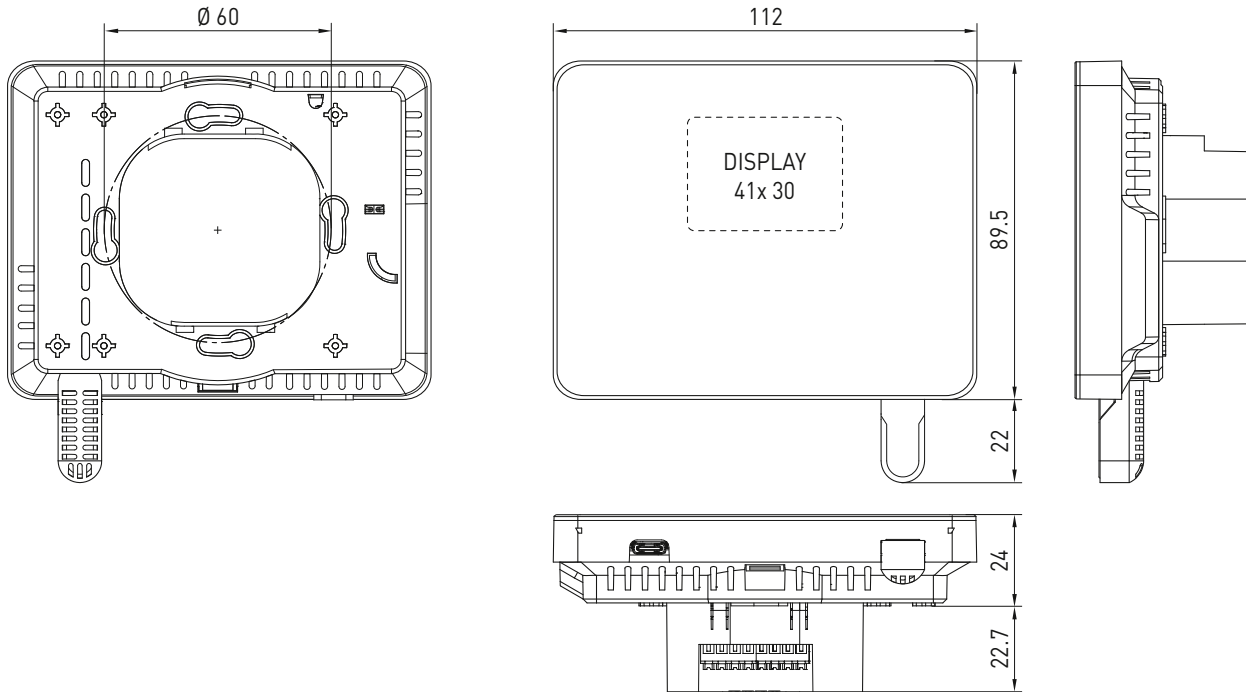

On-wall version
 housing **Iduna 3 (AP)**
 [mm]

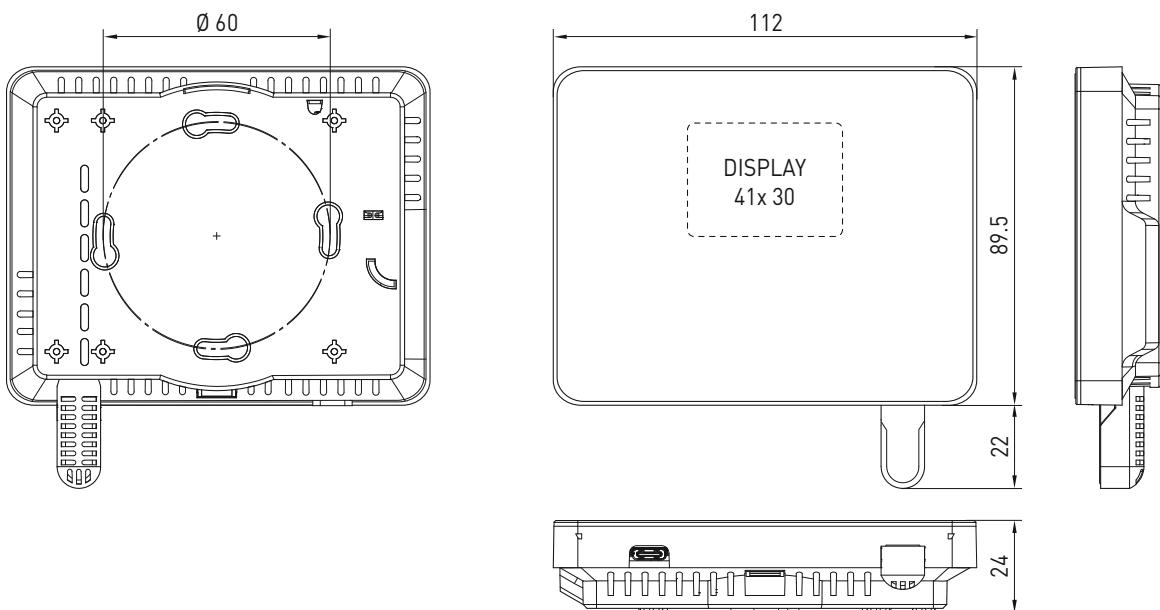

Note: For surface-mounted models,
 the electrical connection is made with
 the housing open.

BASIC MODELS



Room control units
 for temperature
 adjustment



Type 1301



Type 1302

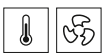

Room control units
 for temperature and
 fan adjustment



Type 1401



Type 1402



WARNING: Turn off the power before starting wiring!

Connection diagram
In-wall version

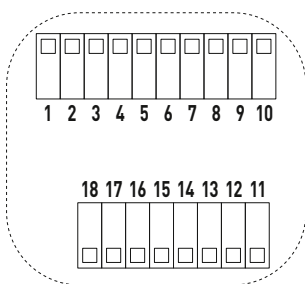

RYMASKON 1000-MOD Interface
In-wall version (RTU cable)

- 1 free
- 2 free
- 3 free
- 4 free
- 5 free
- 6 free
- 7 free
- 8 free
- 9 GND (DI2)
- 10 DI2
- 11 UB+ 24V AC/DC
- 12 UB- GND AC/DC
- 13 NTC10K (DI1, potential-free)
- 14 GND (NTC10K/DI1)
- 15 Modbus A
- 16 Modbus B
- 17 Modbus A
- 18 Modbus B

RYMASKON 1000-WMOD Interface
In-wall version (Wireless)

- 1 free
 - 2 free
 - 3 free
 - 4 free
 - 5 free
 - 6 free
 - 7 free
 - 8 free
 - 9 GND (DI2)
 - 10 DI2
 - 11 UB+ 24V AC/DC
 - 12 UB- GND AC/DC
 - 13 NTC10K (DI1, potential-free)
 - 14 GND (NTC10K/DI1)
 - 15 free
 - 16 free
 - 17 free
 - 18 free
-

Connection diagram
On-wall version

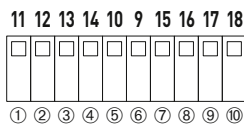

RYMASKON 1000-MOD Interface
On-wall version (RTU cable)

- 11 UB+ 24V AC/DC
- 12 UB- GND AC/DC
- 13 NTC10K (DI1, potential-free)
- 14 GND (NTC10K/DI1)
- 10 DI2
- 9 GND (DI2)
- 15 Modbus A
- 16 Modbus B
- 17 Modbus A
- 18 Modbus B

RYMASKON 1000-WMOD Interface
On-wall version (Wireless)

- 11 UB+ 24V AC/DC
 - 12 UB- GND AC/DC
 - 13 NTC10K (DI1, potential-free)
 - 14 GND (NTC10K/DI1)
 - 10 DI2
 - 9 GND (DI2)
 - 15 free
 - 16 free
 - 17 free
 - 18 free
-

RYMASKON® 1000 Interface (series)
 Number key for type versions

R Y M 1 - X 0 X X - X X 1 X - 0 X X

- Pos. 1-4 Type name**
RYMASKON 1000
- Pos. 5 Housing | setpoint adjustment**
Iduna 3 | Temperature
Iduna 3 | Temperature + Fan
- Pos. 6 Unit type**
Interface
- Pos. 7 Housing colour**
White
Black
- Pos. 8 Visual indication**
TFT display (2.0")
- Pos. 9 Communication/ output**
Modbus
W-Modbus
- Pos. 10 Sensors**
T [°C/°F], RH [%]
T [°C/°F], RH [%], CO2 [ppm]
T [°C/°F], RH [%], VOC [%]
T [°C/°F], RH [%], CO2 [ppm], VOC [%]
- Pos. 11 Voltage supply**
24V AC/DC
- Pos. 12 Mounting**
on in-wall flush box, Ø55 mm
on-wall
- Pos. 14-15 Touch key extension**
Basic model (cf. **Pos. 5**)
including room occupancy
+ **B** (1 sun protection)
+ **BB** (2 sun protection)
+ **L** (1 light)
+ **LL** (2 light)
+ **LB** (1 light, 1 sun protection)

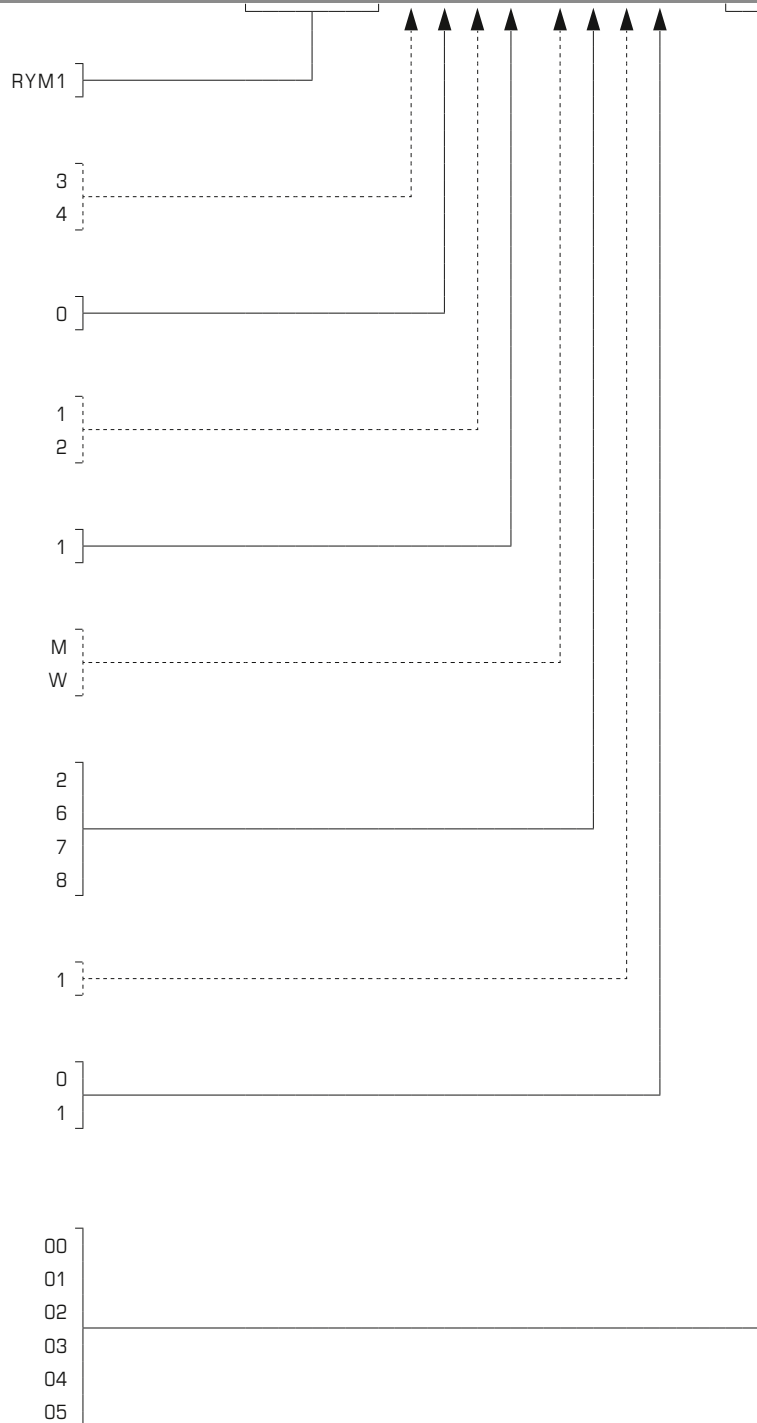

Sensors

- T** Temperature [°C/°F]
- RH** Relative humidity [%]
- CO2** Carbon dioxide [ppm]
- VOC** Air quality [%]

RYMASKON® 130x Interface (basic models) Room control units for temperature adjustment						
Type / WG02	Communi- cation	Measuring element	Control system	Colour / Housing	Display	Item no.
RYMASKON® 130x				Iduna 3		in-wall version
RYM 1301-RH-MOD	Modbus	T RH	T - R	white	■	RYM1-3011-M210-000
RYM 1302-RH-MOD	Modbus	T RH	T - R	black	■	RYM1-3021-M210-000
RYM 1301-RH-WMOD	W-Modbus	T RH	T - R	white	■	RYM1-3011-W210-000
RYM 1302-RH-WMOD	W-Modbus	T RH	T - R	black	■	RYM1-3021-W210-000
RYMASKON® 130x AP				Iduna 3 (AP)		on-wall version
RYM 1301-RH-MOD-AP	Modbus	T RH	T - R	white	■	RYM1-3011-M211-000
RYM 1302-RH-MOD-AP	Modbus	T RH	T - R	black	■	RYM1-3021-M211-000
RYM 1301-RH-WMOD-AP	W-Modbus	T RH	T - R	white	■	RYM1-3011-W211-000
RYM 1302-RH-WMOD-AP	W-Modbus	T RH	T - R	black	■	RYM1-3021-W211-000
Measuring element / control system:	T = Temperature sensor (basic equipment) RH = Humidity sensor		T = Temperature F = Fan R = Room occupancy			

RYMASKON® 140x Interface (basic models) Room control units for temperature and fan adjustment						
Type / WG02	Communi- cation	Measuring element	Control system	Colour / Housing	Display	Item no.
RYMASKON® 130x				Iduna 3		in-wall version
RYM 1301-RH-MOD	Modbus	T RH	T - R	white	■	RYM1-3011-M210-000
RYM 1302-RH-MOD	Modbus	T RH	T - R	black	■	RYM1-3021-M210-000
RYM 1301-RH-WMOD	W-Modbus	T RH	T - R	white	■	RYM1-3011-W210-000
RYM 1302-RH-WMOD	W-Modbus	T RH	T - R	black	■	RYM1-3021-W210-000
RYMASKON® 130x AP				Iduna 3 (AP)		on-wall version
RYM 1301-RH-MOD-AP	Modbus	T RH	T - R	white	■	RYM1-3011-M211-000
RYM 1302-RH-MOD-AP	Modbus	T RH	T - R	black	■	RYM1-3021-M211-000
RYM 1301-RH-WMOD-AP	W-Modbus	T RH	T - R	white	■	RYM1-3011-W211-000
RYM 1302-RH-WMOD-AP	W-Modbus	T RH	T - R	black	■	RYM1-3021-W211-000
Measuring element / control system:	T = Temperature sensor (basic equipment) RH = Humidity sensor		T = Temperature F = Fan R = Room occupancy			

OPTIONS		
Measuring elements:	CO2 = CO2 sensor	Extra charge
	VOC = VOC sensor	Extra charge
Control:	B / L Keys for sun protection and/or light (cf. Pos. 14-15)	on request
Communication:	without Modbus	on request
Optional:	Other type versions available upon request! For configuration options, see number key (left)	

ACCESSORIES		
GW-wModbus	Gateway W-Modbus (Wireless) for radio-based connection to Modbus networks, operating modes 'Gateway' (Master) and 'Node' (adapter function for max. 1 wired sensor)	1801-1211-1101-000
GW-wModbus Pro	operating modes 'Gateway' (Master) and 'Node Pro' (adapter function for max. 16 wired sensors)	1801-1211-1101-100
LA-Modbus	Line termination device (with terminating resistor) as an active bus termination	1906-1300-0000-100
Software:	S+S Configuration Tool configuration software (PC) is available as a free download from www.spluss.de	

CONFIGURATION

General information and configuration menu

[Configuration register](#)

[Save to non-volatile memory \(EEPROM\)](#)
[SaveToEEPROM_2013](#)

[Menu structure](#)
[Configuration menu](#)

Configuration (Main)

- 1 **Device Info**
 - Serial Number
 - Device type
 - Device ID
 - Manufacturer
 - Operating time
 - SW Version
 - User Manual (QR code)
- 2 **Modbus (type-dependent)**
 - Bus Address
 - Baud Rate
 - Parity / Stop Bits
- 2 **W Modbus (type-dependent)**
 - Bus Address
 - NW State
 - NW Quality
 - GW Pairing
 - Bluetooth (AppMode)
- 3 **Date / Time**
 - Date Format
 - Date Adjust
 - Time Format
 - Time Adjust
 - Summer Time
- 4 **Factory Reset**
 - confirm
- 5 **Save / Exit**
 - confirm
- 6 **Discard / Exit**
 - confirm

1.0 General configuration

The unit can be configured in three ways:

- **Display (unit)**
 Manual input via Configuration **menu** directly on the unit's display.
 (RS485 interface configuration)
 - **Configuration Tool (PC)**
 Input/upload to the unit via PC using configuration **software** (USB-C interface).
 (Configuration of the RS485 interface and configuration of all other unit parameters)
 - **BMS (Modbus)**
 Input in Modbus **Register table** via the bus (RS485 interface).
 (No configuration of the RS485 interface, otherwise configuration of all other unit parameters)
- The configuration parameters are stored permanently in the unit's non-volatile memory. To do this, all changes must be **saved** to the non-volatile memory (EEPROM) using the Save parameter once the configuration is finished.

Configurable Modbus parameters (type-dependent)

Modbus	Value range
Bus address	1 (default) ... 247
Baudrate	9600 / 19200 (default) / 38400 / 57600 / 115200 baud
Parity / stop bits	NONE (none, 1 stop bit) EVEN (even, 1 stop bit) (default) ODD (odd, 1 stop bit) NONE (none, 2 stop bits)

1.1 Configuration menu (Display)

The menu is used to configure the RS485 interface via the unit's display. To navigate the menu structure and edit entries, there are additional functions assigned to the **PRESENCE** (🏠), **SENSOR** (🌡️) keys and the **UP** (↑) and **DOWN** (↓) arrow keys for temperature adjustment (see table).

Key assignment in the configuration menu

🏠	BACK	One level back in the menu structure
	CANCEL	Cancel the ongoing editing
↑ 🌡️ ↓	SELECT	Navigate through the list (up/down)
	VALUE	Change the entry value (increase/decrease)
🌡️	OK	Confirm the entry value
	NEXT	Next menu level or next editing field of the value

Accessing the configuration menu

To access the configuration menu, you have to press and hold down the **SENSOR** (🌡️) key, immediately followed by the **PRESENCE** (🏠) key. **Press both keys together for 3 s** (Fig. 001).

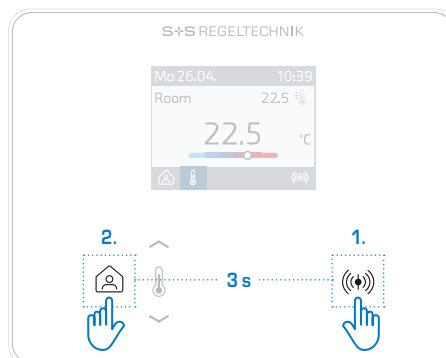

Fig. 001 Accessing the configuration menu

[Configuration register](#)

[PIN config menu](#)
[PIN_2008](#)
 (Default: 1111)

Entering the PIN number

After accessing the configuration menu, you first have to enter a 4-digit **PIN** number (Fig. 002). The number sequence of the PIN can be changed via the Modbus register or the PIN verification can be permanently deactivated (default: 1111 / no PIN: 0000).

The top menu level Device Info (**Main**) then opens with the first entry (Fig. 003).

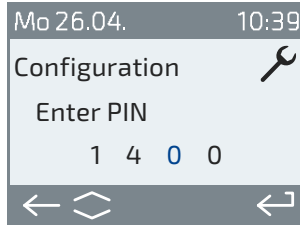

Fig. 002 PIN entry

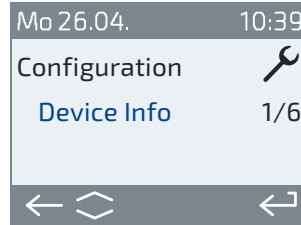

Fig. 003 First entry (Main)

Confirming a value

The value of the entry is initially inactive (Fig. 004).

Activation is via the **SENSOR** (☎) key.

The **active value** is then displayed in a **focus colour** (Fig. 005).

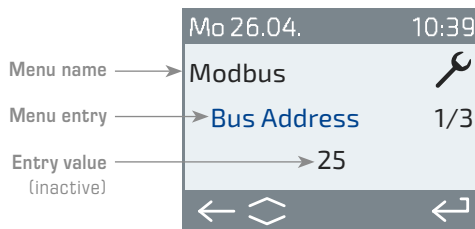

Fig. 004 Editing inactive

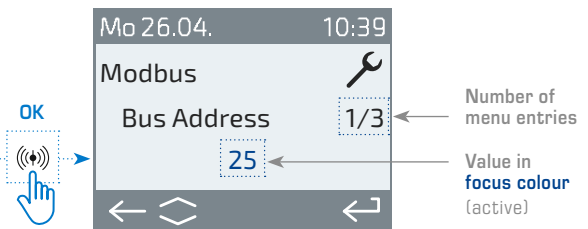

Fig. 005 Active value in focus colour

Factory reset

All parameters can be reset in the **Factory Reset** level (Fig. 006).

After confirming with 'Yes', the unit restores the factory settings (bus parameters are retained) and performs a restart (Fig. 007).



Fig. 006 Accessing factory reset

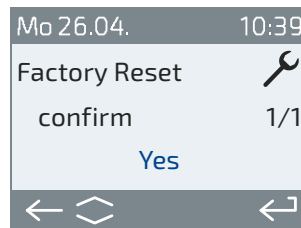

Fig. 007 Factory reset confirmation

Exiting the configuration

Saving and exiting takes place in the **Safe / Exit** level (Fig. 008).

This way, all entered values are saved permanently.

Exiting **without saving** takes place in the **Discard / Exit** level (Fig. 009).

This **cancels** the configuration and all entries are discarded.

After confirming with 'Yes', the configuration menu closes and the **Home screen** (setpoint temperature adjustment) appears on the display.

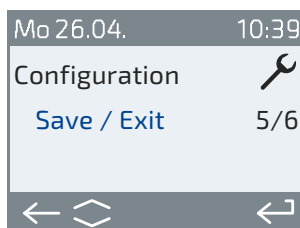

Fig. 008 Saving and exiting

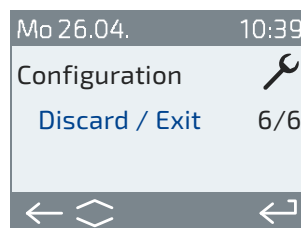

Fig. 009 Exiting without saving

1.2 Configuration software (PC)

The PC software **SplusS-ConfigurationTool** is used to configure the RS485 interface and all other unit parameters. It is also possible to save an existing **unit configuration** within the software and **transfer** it to other units. Thanks to the innovative **CuRA**-function (Customised Register Assignment), each data point can be assigned an individual register address (see chapter 1.5).

The software accesses the Modbus structure of the unit and can read (r) or read/write (r/w) all values. The configuration options range from the adjustment range of the set values to the brightness setting of the display and the bus parameters. It will still be possible to input data via the **RS485 interface**.

System requirements (PC)

Windows operating system: Win7 / Win8.x / Win10 / Win11
System type: 32-bit or 64-bit
CPU: 2 GHz
HD space: 100 MB
Working memory (RAM): min. 1 GB (2 GB for Win11)
Screen resolution: min. 1024 x 768 px
USB connection required!

Download (exe)

The SplusS-ConfigurationTool can be downloaded online from the Download section at <https://www.spluss.de/en/rymaskon-room-automation/digital-room-thermostat/interface-room-control-unit/>

Unit connection

The unit is connected via the **USB-C**-interface on the underside of its housing (Fig. 010). You can use a commercially available cable for this (not included in the scope of delivery). The unit does not require an additional power supply.

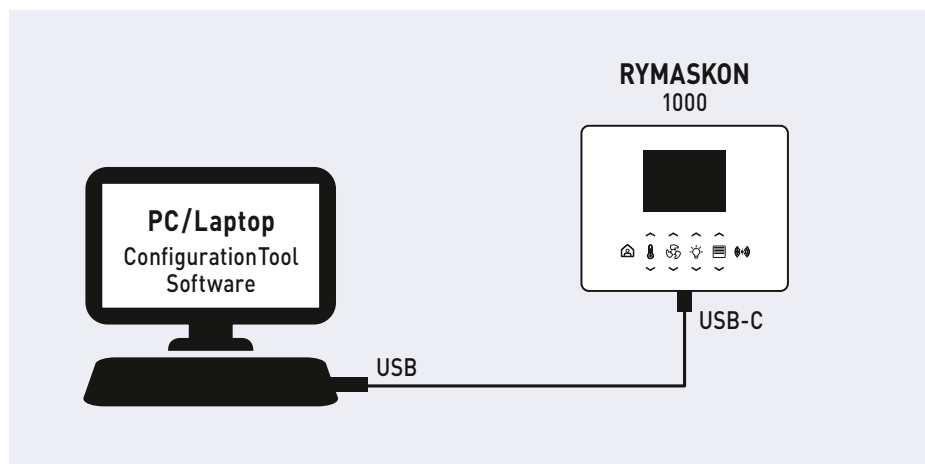

Fig. 010 Connection via USB-C interface

Configuration register

The notes on the side refer to the relevant configuration register.

Note: The register address information refers to the original number (not to the favourites list).

1.3 Configuration register (higher-level system)

In addition to the data points that can be used to operate the unit (data register), the unit can also be configured via the Modbus register. Input is made via the BMS (RS485 interface) or by means of the configuration software (PC).

You can find more relevant information in the document '**RYMASKON® 1000 Interface – Configuration register**' provided in the Download section for the unit at <https://www.spluss.de/en/rymaskon-room-automation/digital-room-thermostat/interface-room-control-unit/>

« W-Modbus

1.4 W-Modbus

The RYMASKON® 1000 is integrated into a W-Modbus network using the **configuration menu** (refer to chapter 1.1) directly on the unit (display).

Network connection

The connection to the W-Modbus gateway is established at the **Pairing** level. Deactivation takes place automatically when you exit the Pairing mode on the master gateway. Even the network **status** and network **quality** can be queried via the menu.

W-Modbus App

The Lumenradio W-Modbus App can access W-Modbus units. To do this, **Bluetooth** must first be activated in the configuration menu. The unit then becomes visible for approx. 60 s and can be connected via the app. The connection remains active until you press **'Disconnect'** in the app or activate Pairing on the unit.

The following data is available in app mode:

- Firmware updates of the wireless module
- Error detection (duplicate bus addresses, communication errors, etc.)
- Individual unit names
- Checking the network setup
- Documentation for the network setup (PDF)

You can find more information via the help function in the app. The app is available for Android and Apple mobile devices through the App Store.

Link for Apple Lumenradio W-Modbus App:
<https://apps.apple.com/de/app/w-modbus/id6472275984>

Link for Android Lumenradio W-Modbus App:
<https://play.google.com/store/apps/details?id=com.lumenradio.wmodbus>



1.5 CuRA (Customised Register Assignment)

The configuration software **SplusS-ConfigurationTool** can be used to assign an **individual register address** to each data point. The individual address assignment can be saved within the software and transferred to other units.

This simplifies the integration of the unit into an existing building automation system and can be done without reprogramming the BMS.

Furthermore, the **CuRA function** can also be used to create register blocks and thus significantly increase the query speed.

1.6 Time setting (time/date)

The unit has a real-time clock that automatically calculates the **time** and **date**. During commissioning, the time and date must be updated **manually** via the configuration menu (display), via the BMS (Modbus register) or using the configuration software (PC).

The time setting is based on standard time (winter time). It is possible to activate an **automatic time change** to summer time, if necessary.

The configured time is retained in the event of a temporary power interruption.

[Configuration register](#)

[Time and date](#)
[Time_Format_2015](#)
[Date_Format_2016](#)
[Time_SetSummerWinter_2017](#)

[Data register](#)

[Time and date](#)
[Date_Time_2018-2023](#)

ICONS

Screen areas and explanation of icons

DISPLAY / MENU

APPEARANCE (configurable)

Display mode (light/dark), brightness, language, units and individual labels can be selected.

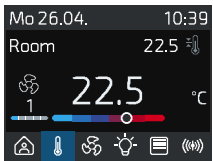

Display Darkmode

HOME SCREEN

The default view is the setpoint temperature adjustment with fan levels if necessary.

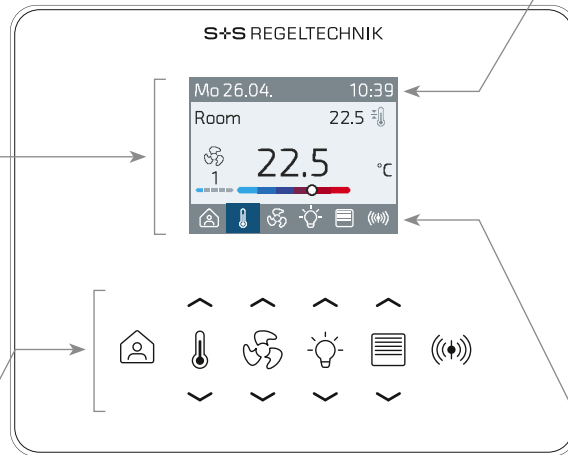
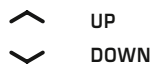

Fig. 011 Icons, using type 1401-LB as an example

KEYPAD (TOUCHKEYS)

SETPOINT ADJUSTMENT AND MENU ACCESS VIA ARROW KEYS



Note:
Some keys are assigned additional functions in the configuration menu.

BASIC FUNCTIONS MENU ACCESS FOR PRESENCE AND SENSORS

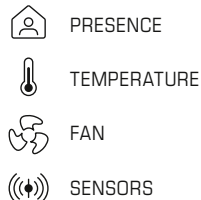

ADDITIONAL FUNCTIONS KEY EXTENSION FOR 1 OR 2 ZONES

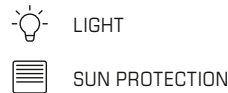

Options:
1x light / 1x sun protection,
1x or 2x light,
1x or 2x sun protection

HEADER

Mo 26.04. 10:39

STANDARD DISPLAY
Weekday, date, time, summer/winter time (can be set via Modbus).

Mo 26.04. 10:39

STATUS DISPLAY
ROOM CLIMATE
WINDOW CONTACT
DEW POINT
FROST PROTECTION
ECO MODE

Mo 26.04. 10:39

MESSAGES
USB-C
FAULT / ALARM

FOOTER



MENU STATUS (Options are type-dependent)

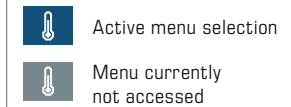

Note:
Only functions integrated in the unit type are also displayed as an icon in the footer.

OVERVIEW OF ICONS AND ABBREVIATIONS

PRESENCE PRESENT	TEMPERATURE	WINDOW CONTACT	ABBREVIATIONS: BMS Building Management System HMI Human Machine Interface GUI Graphical User Interface CSC Colour Scale (sensors) DI Digital Input
PRESENCE ABSENT	HEAT	DEW POINT	
SENSORS	COOL	FROST PROTECTION	
FAN	OFF	ECO MODE	
SUN PROTECTION / BLIND	AUTOMATIC	USB-C	
LIGHT	KEY LOCK / LOCKED	FAULT / ALARM	

USER INTERFACE

Layout and operating modes

[Configuration register](#)

Darkmode

[Display_Darkmode_2024](#)

Display Brightness

[Display_Brightness_2011](#)

Language

[Language_2009](#)

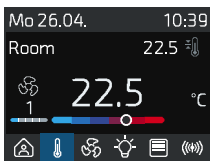

Display Darkmode

[Data register](#)

Lock for individual keys or key pairs:

[Temperature, Fan, Presence](#)
[RCBBMS_409_bitField](#)

Sun protect

[SP_AutoMode_700_bitField](#)

Light

[L_AutoMode_1100_bitField](#)

[Configuration register](#)

Time and date

[Time_Format_2015](#)

[Date_Format_2016](#)

[Time_SetSummerWinter_2017](#)

[Data register](#)

Time and date

[Date_Time_2018-2023](#)

Header Icons Modbus

[HeaderIconModbus_411_bitField](#)

2.0 User interface, general information

In addition to the bright display view (Fig. 012), you can also activate **darkmode**. The **brightness** can be individually set.

Six **languages** are available:

German, English (default), Spanish, French, Italian, Russian

Default **labels** are already provided in each language (see top left in the menu content, e.g. Room) for specific environments. Regardless of this, each label can be individually changed.

You can use a maximum of 12 characters for this.

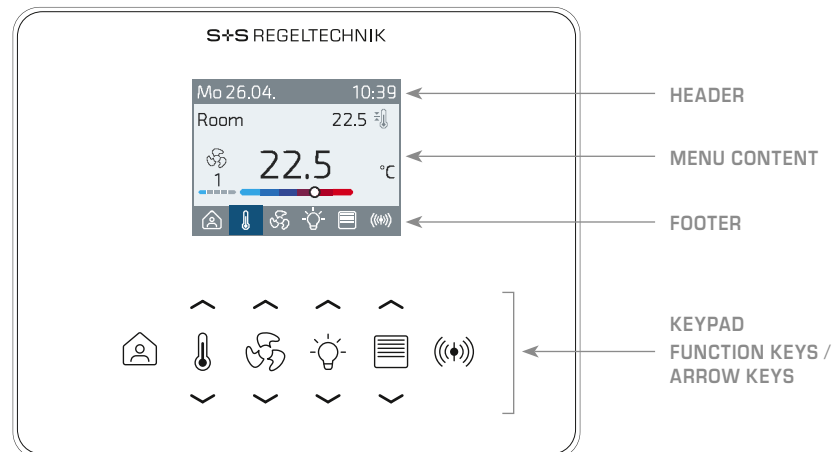

Fig. 012 HMI layout

2.1 HMI layout (Human Machine Interface)

Keypad (touch keys)

Operation takes place directly via the keypad.

The menus are accessed via the labelled function keys themselves or via the corresponding **UP** and **DOWN** arrow keys.

The values in the menu can also be adjusted using the arrow keys.

The **BMS** can temporarily **block** individual keys or key pairs for the user on site.

Note: The user interface corresponds to the respective **unit type**, i.e., only integrated functions or sensors are available for selection.

Header on the display (Header)

The **date** and **time** are constantly shown in the header.

In addition to the time and date format, you can also configure an automatic switchover between summer and winter time.

For further relevant information, see chapter 1.6 'Time setting (time/date)'.
The **Header Icons Modbus** parameters can be used to show various icons on the BMS (Fig. 013). If the icons are switched via a configured DI input, you have to observe chapter 7 'Inputs'.

In normal operation, you can display the following **room climate** icons in parallel:

Window contact – Dew point – Frost protection – ECO mode

In the event of a fault or active access via the USB-C interface, the following **status message** icons are **automatically** displayed (Fig. 014):

USB-C interface connected – fault / alarm

When a status message stops, the display automatically switches back to the configured room climate icons. The appearance and position of the header icons are permanently programmed into the unit and cannot be changed.



Fig. 013 Header - Room climate



Fig. 014 Header - Status messages

USER INTERFACE

Layout and
operating modes

2.1 HMI layout (continuation)

Footer on the display (Footer)

All available functions are shown in the footer (depending on unit type).

The icon of the menu currently open is highlighted in colour in the footer.

The appearance and position of the footer icons are permanently programmed into the unit and cannot be changed.

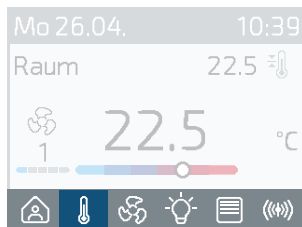

Fig. 015 Footer - Temperature active

2.2 Screen saver

The screen saver helps to reduce energy consumption.

In the default settings, the graphical user interface is automatically deactivated if the unit is not operated for 20 seconds. The screen saver appears.

For this, the display switches to black and only the current temperature display moves within the screen area.

Touching **any key** reactivates the graphical user interface (GUI) and the **Home screen** (Setpoint temperature adjustment) appears on the display.

[Configuration register](#)

[Screen saver](#)

[ScreenSaver_Timeout_2012](#)

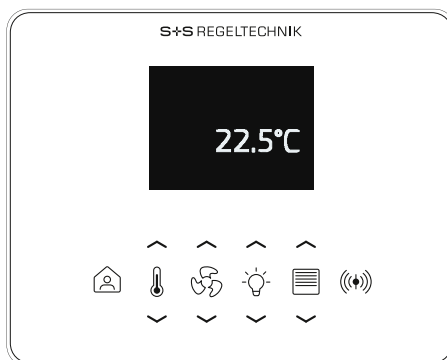

Fig. 016 Screen saver

2.3 Cleaning mode (key lock for 20 s)

To access the cleaning mode, you must press and hold down the **SENSOR** (⦿) key, immediately followed by the **DOWN** (∨) arrow key for the temperature adjustment. Press both keys together for **3 seconds** (Fig. 017).

Immediately afterwards, all buttons are temporarily locked for **20 seconds**. Meanwhile, the **cleaning countdown** counts down on the display (Fig. 018).

After the countdown has finished, the cleaning mode **ends automatically** and the **Home screen** (Setpoint temperature adjustment) appears on the display.

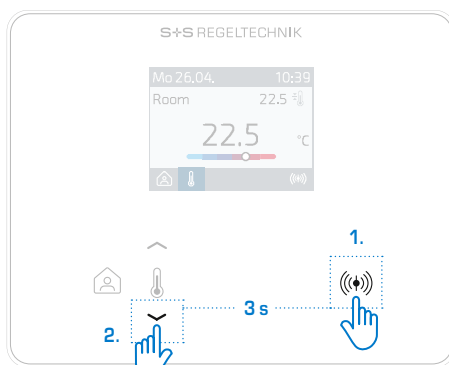

Fig. 017 Accessing the cleaning mode

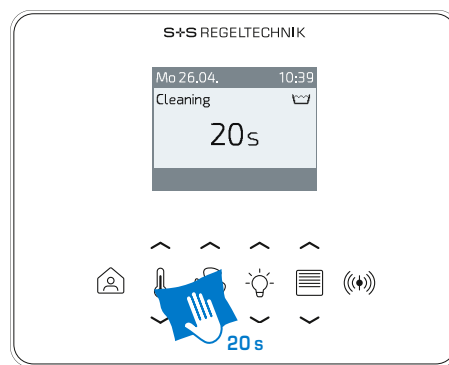

Fig. 018 Cleaning mode - Key lock with countdown

2.4 Key lock (child safety lock)

To activate or deactivate the key lock, press and hold the **SENSOR** (⦿) key, immediately followed by the **UP** (∧) arrow key for temperature adjustment. Press both keys together for **3 seconds** (Fig. 019).

The active key lock is indicated in the header by the **LOCKED** (🔒) icon (Fig. 020).

After deactivation, the Home screen (Setpoint temperature adjustment) appears on the display.

Note: The **BMS** can block individual keys or key pairs for the user on site. This is not indicated on the display. Deactivation is only possible via the BMS.

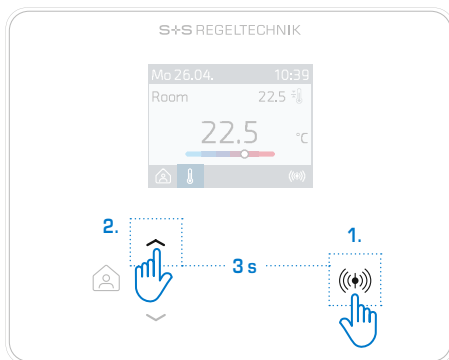

Fig. 019 Activating / deactivating the key lock

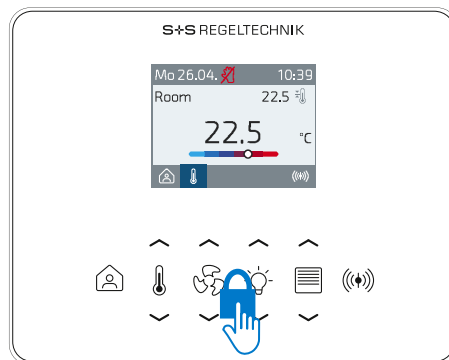

Fig. 020 Icon in header - Key lock active

TEMPERATURE SETPOINT

Display and adjustment

[Data register](#)

[Room Climate Controlled By BMS](#)
 RCBMS_409_bitField

3.0 Temp menu, general information (Setpoint temperature adjustment)

The setpoint temperature is set using the **UP** and **DOWN** arrow keys next to the **TEMPERATURE** icon (Fig. 021).

The BMS can use the **Room Climate Controlled By BMS** parameter to temporarily block manual adjustment (Manual mode) for the user. This locking is shown on the display.

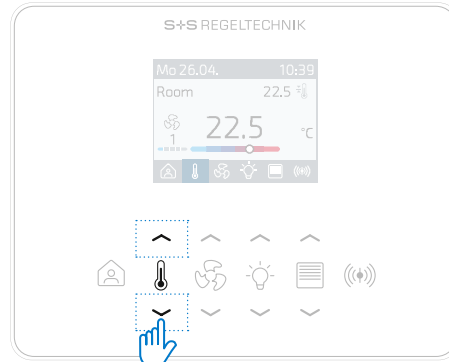

Fig. 021 Setpoint temperature adjustment via arrow keys

Display

In the Temp menu, it is possible to show or hide the current temperature, unit, setpoint temperature, operating mode, label and current fan levels (Fig. 022). The display is configured via the Modbus register.

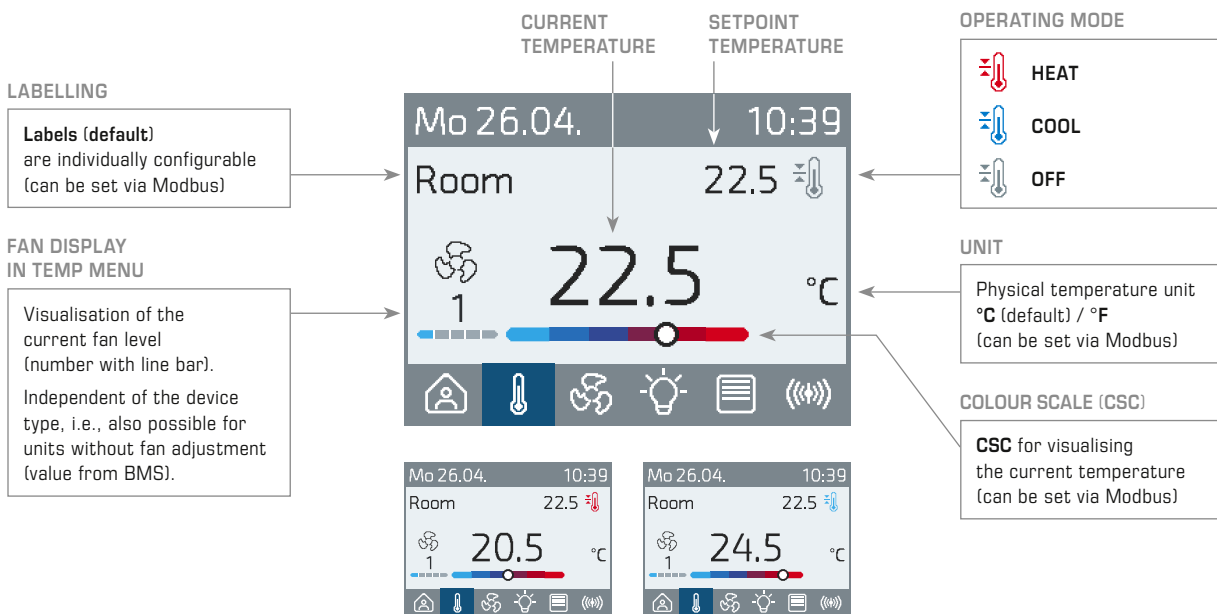

Fig. 022 Temp menu elements

Configuration register

Current Temp Mapping
CurrentTemp_Mapping_3650

Temp unit
Temp_Unit_2010

Display Temp Setpoint
Setpoint_Temp_Display_3602

Display Current Temp
CurrentTemp_Display_3651

Data register

Temp Sensor 1 int. value
TempS1Int_Value_100

Temp Sensor 2 ext. value
TempS2Ext_Value_106

Temp Sensor 3 bus value
TempS3Bus_Value_120

Configuration register

Temp Setpoint Offset Step Size
Setpoint_Temp_Offset_StepSize_3600

Display OpMode
OpMode_Display_3601

Temp Setpoint After Reboot
Setpoint_Temp_AfterReboot_3603

Temp Setpoint Offset Min-Max After Reboot
Setpoint_Temp_Offset_MinMax_AfterReboot_3604

Display Fan In Temp Menu
Fan_DisplayInTempMenu_3764

Data register

Temp Setpoint
Setpoint_Temp_400

Temp Setpoint Offset
Setpoint_Temp_Offset_401

Temp Setpoint Absolut
Setpoint_Temp_Absolut_402

Temp Setpoint Offset Min-Max
Setpoint_Temp_Offset_MinMax_403

OpMode Status
OpMode_Status_404

3.1 Current temperature

A total of three **temperature channels** is available. These can be assigned to the current temperature in the configuration tab via the **Current Temp Mapping** parameter.

The **values** of the individual channels are stored in the data register (read or read/write register).

1. Temperature channel: **Internal sensor** (default)
Parameter: **Temp Sensor 1 int. value**
2. Temperature channel: **Externer Sensor** (input must be appropriately configured)
Parameter: **Temp Sensor 2 ext. value**
3. Temperature channel: **Bus value**
Parameter: **Temp Sensor 3 bus value**

The temperature **unit** can be configured for all channels.
Default °C can be changed to °F.

The **colour scale (CSC)** is mapped to the current temperature and is used for better visualisation of cold or warm environments. Each sensor has its own CSC, which is factory-set to a value range in °C. The CSC must be adjusted when switching to °F.
(For configuration, please see chapter 5)

The **label** is mapped to the sensor and can be configured via the **Temp Sensor...Label** parameter for each of the three temperature channels (internal/external/bus).
(For details, please see chapter 5)

The **display** of the current temperature can be hidden using the **Display Current Temp** parameter or replaced with another sensor (e.g. relative humidity or CO2).

3.2 Setpoint temperature

The display of the setpoint temperature can be configured as follows using the **Display Temp Setpoint** parameter:

- **Nothing displayed**
- **Temp Setpoint Absolut** (default)
- **Temp Setpoint Offset**

Alternatively, you can use the **Display Temp Setpoint** parameter to display another sensor instead of the setpoint temperature (e.g. relative humidity or CO2). If set to Alternative and the setpoint temperature is changed using the keys, the display switches briefly to the setpoint temperature and then switches back to the alternative one.

The absolute setpoint temperature (**Temp Setpoint Absolut**) is calculated from the sum of the setpoint and offset. The setpoint (**Temp Setpoint**) is set via the bus or configuration software. The offset (**Temp Setpoint Offset**) can be changed via the keys or bus during operation.

The **Temp Setpoint Offset Min-Max** parameter can be used to specify the limits for the setpoint adjustment via the keys.

The values **Temp Setpoint** and **Temp Setpoint Offset Min-Max** are stored in the volatile memory (VRAM) and are reset to their default after the unit is restarted. The default parameters can be specified via the two **Temp Setpoint After Reboot** and **Temp Setpoint Offset Min-Max After Reboot** parameters.

The setpoint increment is set with the **Temp Setpoint Offset Step Size** parameter.

3.3 Operating mode

The BMS can display the following **icons** to help visualise the current operating mode:

 **COOL** –  **HEAT** –  **OFF** (cooling/heating off)

The specification is made via the BMS (not on the unit itself) using the **OpMode Status** parameter. The icons can be hidden using the **Display OpMode** parameter.

3.4 Fan display

The display of the current fan level (number with line bar) in the Temp menu can be shown or hidden using the **Display Fan In Temp Menu** parameter.

Note: Fan levels are displayed in the Temp menu regardless of whether the unit has or doesn't have fan adjustment. For units without fan adjustment, the fan levels are specified exclusively by the BMS.

The operating principle and configuration of the fan adjustment are explained in the subsequent chapter 4 'Fan menu'.

FAN CONTROL

Display and adjustment

[Configuration register](#)

[Display Fan In Temp Menu](#)
[Fan_DisplayInTempMenu_3764](#)

[Data register](#)

[Room Climate Controlled By BMS](#)
[RCBBMS_409_bitField](#)

4.0 Fan menu, general information (fan adjustment)

The **Fan menu** is only available for unit types **with** fan adjustment. The user can adjust the fan manually (Manual mode) using the **UP** and **DOWN** arrow keys next to the **FAN** (Fig. 023).

The **fan levels** can be displayed in the **Temp menu** by the BMS, regardless of the unit type (see chapter 3.4 'Fan display').

The BMS can use the **Room Climate Controlled By BMS** parameter to temporarily block manual adjustment (Manual mode) for the user. This locking is not shown on the display.

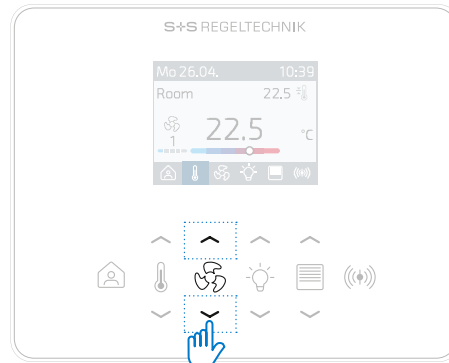

Fig. 023 Fan adjustment via arrow keys

Display

Fan levels, number of fan steps, operating statuses (Auto/Off) and labels can be displayed in the fan menu (Fig. 024). The display is configured via the Modbus register.

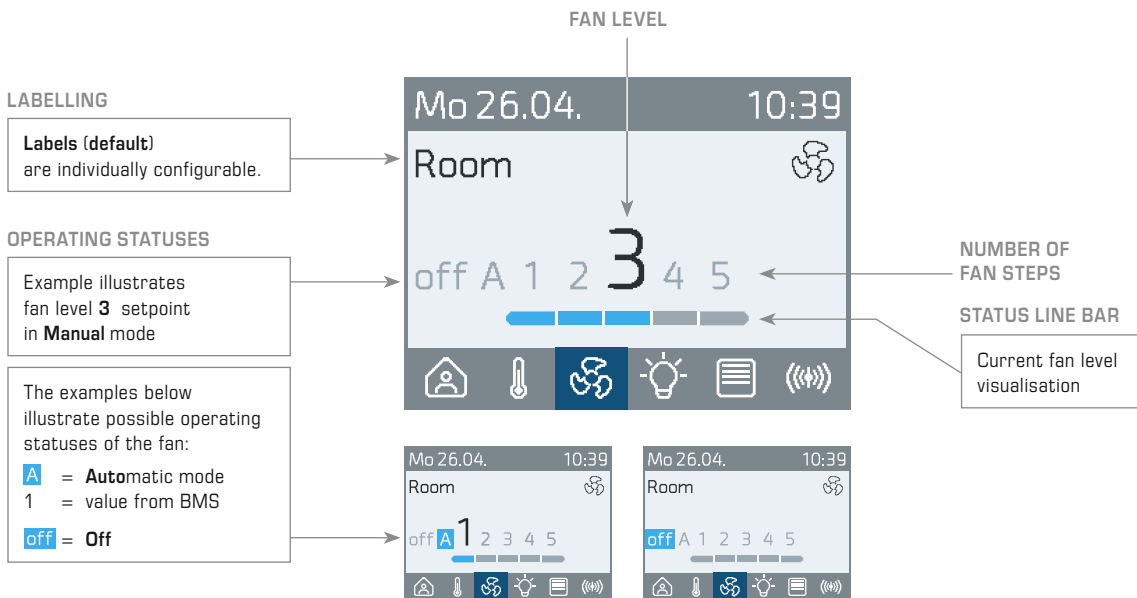

Fig. 024 Fan menu elements

[Configuration register](#)

Number of Fan Steps
 Fan_NumberOfSteps_3762

Enable Fan Auto / Off in Manual mode
 Fan_EnableAutoOff_3763

Fan Label
 Fan_Label_3750-3761

[Data register](#)

Fan Auto Mode
 Fan_AutoMode_406

Fan Level
 Setpoint_Fan_Level_407

Room Climate Controlled By BMS
 RCBBMS_409_bitField

4.1 Number of fan steps

The number of fan steps (1-5) is entered via the **Number of Fan Steps** parameter according to the fan unit in operation to obtain a realistic representation.

4.2 Fan operating status (Auto / Off)

The fan has two operating statuses, both of which are enabled for Manual mode by the operator on site via the **Enable Fan Auto / Off** parameter.

Auto = fan in automatic mode (default)
 (the BMS must write the value for the fan level to the Modbus register)

Off = fan off

4.3 Fan label

Default labels are provided for the fan in each language (see chapter 'HMI layout'). Irrespective of this, the label can be changed individually using the **Fan Label** parameter. You can use a maximum of 12 characters for this.

4.4 Setpoint fan level

The entries for fan control in normal operation are made via the two parameters **Fan Auto Mode** and **Fan Level** (see table).

	Status 1 Manual mode	Status 2 Automatic mode
Fan Auto Mode Fan_AutoMode_406	'Manual'	'Auto'
Fan Level Setpoint_Fan_Level_407	'Off / 1...5'	Value from the BMS

If the operator switches to **Automatic** mode via touch keys (Status 2), the **Fan Auto Mode** parameter is automatically switched to 'Auto' and the BMS must specify the fan level (Off / 1...5).

If the BMS wants to change the fan level in manual mode (Status 1), the **Fan Auto Mode** must first be set to 'Auto' and the desired fan level (Off / 1...5) must then be entered.

The last change has priority (Manual or Auto).

The BMS can use the **Room Climate Controlled By BMS** parameter (bit-coded holding register incl. coil mapping) to temporarily block manual adjustment (Manual mode) for the user.

SENSORS & SENSOR MENU

Display, configuration and calibration

5.0 Sensor menu, general information (sensor display)

To access the **Sensor menu**, you have to press the **SENSOR** ((☎)) key (Fig. 025).
 The first activated sensor then appears on the display.
 To switch to the next enabled sensor, press the sensor button again.

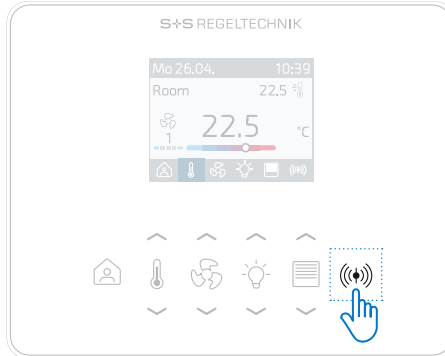

Fig. 025 Accessing the Sensor menu

Sensors and display

All units are equipped with a **digital temperature and humidity sensor** as standard.
Internal sensors for CO2 and VOC are optionally available (depending on unit type).

External sensors can be written to and displayed on the unit via the bus.

It is also possible to connect a **passive sensor** at the input directly to the unit.

The current sensor values are shown on the **display** as a numerical value with a unit and, if necessary, also as a colour scale (Fig. 026). The display is configured via the Modbus register.

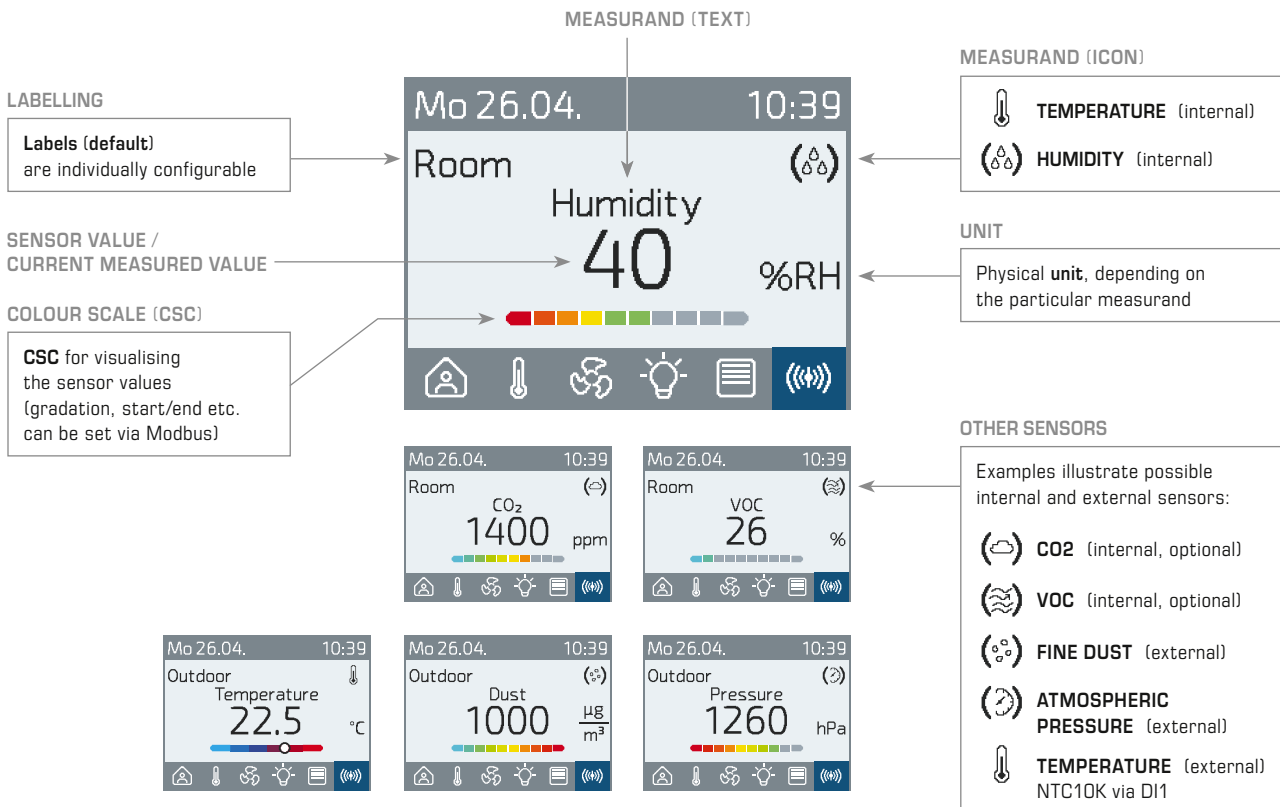

Fig. 026 Sensor menu elements

[Configuration register](#)

Temp Unit
Temp_Unit_2010

Pressure 2 Bus Unit
PressureS2Bus_Unit_3516

VOC Sensor 2 Bus Unit
VOCS2Bus_Unit_3316

5.1 Sensor menu configuration

All internal and external sensors (except for the internal temperature sensor) are enabled for display by default (**Sensor menu display** = enabled).

As soon as the unit receives a measured value, it is displayed in the corresponding sensor menu. The following table shows all the sensors that can be displayed in the sensor menu, including the register addresses.

Physical unit

The temperature unit can be overridden for all temperature channels via the **Temp Unit** parameter (default °C / °F).

If the **atmospheric pressure** (value from BMS) should be indicated on the display, the unit can be selected via the **Pressure Sensor 2 Bus Unit** parameter (default hPa / Pa / mbar / inWC).

For the display of an external **VOC**-sensor (value from BMS) the unit can be selected via the **VOC Sensor 2 Bus Unit** (default % / ppb).

Colour scale (CSC)

For quick visualisation, the measured value is displayed under the numerical value as a colour scale (default). This can be hidden via the **Show Colour Scale** parameter of the respective sensor channel or configured individually via the **Colour Scale Start** and **Colour Scale End** parameters (see table).

Labelling

All sensors come with default **sensor labels** in each language.

Irrespective of this, each label can be changed individually using the **Sensor Label** parameter. You can use a maximum of 12 characters for this.

Sensor register table (excerpt) with holding addresses	Display in sensor menu				Colour scale (CSC)		Labelling	
	Value Value...	Offset Offset...	Averaging time Averaging Time...	Sensor menu display EnableIn SensorMenu...	CSC display EnableColour Scale...	CSC start / end ColourScale_Start/End...	Labelling Label...	
Internal sensors (type-dependent)								
Temp Sensor 1	TempS1Int_...	100	2312	2313	2317	2318	2314 / 2315	2300-2311
RH Sensor 1	HumS1Int_...	101	2412	2413	2417	2418	2414 / 2415	2400-2411
CO2 Sensor 1	CO2S1Int_...	102	2512	2513	2517	2518	2514 / 2515	2500-2511
VOC Sensor 1	VOCS1Int_...	103 (ppb) 104 (%)	-	2613	2617	2618	2614 / 2615	2600-2611
External passive sensor (Input DI1)								
Temp Sensor 2	TempS2Ext_...	106	2912	2913	2917	2918	2914 / 2915	2900-2911
External sensors (Values from BMS)								
Temp Sensor 3	TempS3Bus_...	120	-	-	3017	3018	3014 / 3015	3000-3011
RH Sensor 2	HumS2Bus_...	121	-	-	3117	3118	3114 / 3115	3100-3111
CO2 Sensor 2	CO2S2Bus_...	122	-	-	3217	3218	3214 / 3215	3200-3211
VOC Sensor 2	VOCS2Bus_...	123	-	-	3317	3318	3314 / 3315	3300-3311
PM Sensor 2	PMS2Bus_...	124	-	-	3417	3418	3414 / 3415	3400-3411
Pressure Sensor 2	PressureS2Bus_...	125	-	-	3517	3518	3514 / 3515	3500-3511

[Data register](#)

CO2 Sensor 1 int. auto calibration
CO2S1Int_AutoCalibr_302

5.2 Calibrating the internal CO2 and VOC sensors

Units with an integrated CO2 and/or VOC sensor perform automatic calibration.

Ventilating the rooms regularly with fresh air increases the measuring accuracy of the sensors. The automatic calibration of the CO2 sensor is activated by default. The automatic calibration of the VOC sensor cannot be deactivated.

All that is required for **automatic calibration** (CO2/VOC) is a regular supply of fresh air. The unit recognises this status and automatically performs self-calibration.

Proceed as follows to perform self-calibration:

Open all windows fully or set the air conditioning system to use outdoor air once weekly for 15 - 20 minutes. If possible, everyone should leave the room (CO2) or else the release of volatile organic substances/mixed gases (VOC) should be prevented.

[Data register](#)

CO2 Sensor 1 int. reset auto zero
CO2S1Int_ResetAutozero_300

Manual calibration (CO2) can be carried out independently of automatic calibration.

Proceed as follows to perform manual calibration:

First, open all windows fully or set the air conditioning system to use outdoor air for 15 - 20 minutes. If possible, everyone should leave the room during this time.

Start the **Autozero** process via the bus or the RYMConfig software.

Keep the windows open or the air conditioning system set to use outdoor air.

After **10 minutes**, the manual calibration process (CO2) is ready.

The bus value for Autozero switches back to **OFF**.

PRESENCE / ABSENCE

Display and configuration

[Configuration register](#)

[Presence Function](#)
[Presence_Function_3800](#)

[Data register](#)

[Presence Status](#)
[Presence_Status_405](#)

[Room Climate Controlled By BMS](#)
[RCBBMS_409_bitField](#)

6.0 Presence menu, general information (changing presence)

The **PRESENCE**  key is pressed to open the Presence menu (Fig. 027) and carry out a presence change. In the 'absent' status, unit operation is defined via **Presence Function**.

The BMS can temporarily disable the PRESENCE key via the **Room Climate Controlled By BMS** parameter.

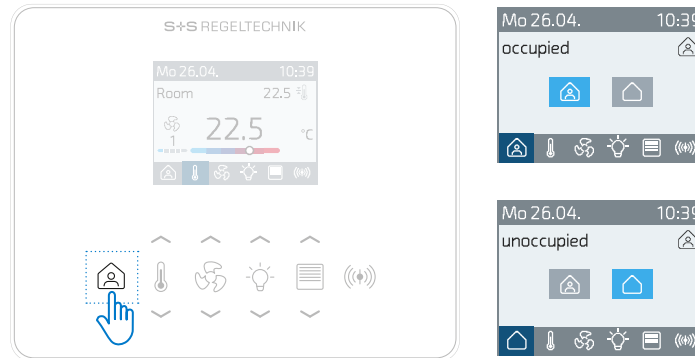





Fig. 027 Accessing the Presence menu

Display and labelling

Active presence status is indicated by the **OCCUPIED**  or **UNOCCUPIED**  icons.

The labels in the respective language are permanently stored and cannot be changed by the user.

Language		
Englisch (default)	occupied	unoccupied
Deutsch	anwesend	abwesend
Französisch	présent	absent
Spanisch	presente	ausente
Italienisch	presente	assente
Russisch	занят	свободно



Input 1 and input 2 may only be switched to GND (potential-free)!

Applying voltage to the two inputs will destroy the unit!

Presence change

The room occupancy is stored in the **Presence Status** register and the icon 'occupied (present)' or 'unoccupied (absent)' is controlled by this. The **Presence Status** register can be influenced in three ways:

- Via the **PRESENCE** key on the unit
- Via the **Presence Modbus** register
- Via the digital inputs **DI1** / **DI2**

PRESENCE

Logic

6.1 Presence status

You can see how the Presence Change parameters influence each other in the following simplified illustration (Fig. 028):

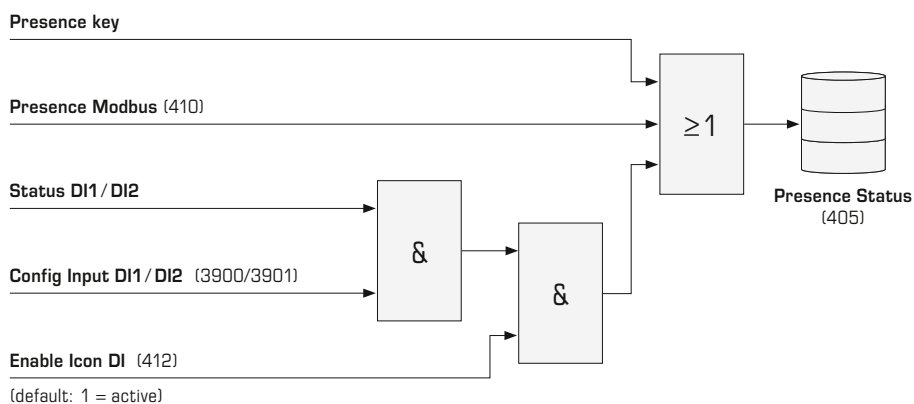

Fig. 028 Presence change

[Configuration register](#)

Input 1 Config
 Input1_Config_3900

Input 2 Config
 Input2_Config_3901

Presence Function
 Presence_Function_3800

Presence Enable DI Reboot
 Enable_PresenceDI_Reboot_3801

[Data register](#)

D1 Input Status
 D1Input_Status_126

D2 Input Status
 D2Input_Status_127

Presence Modbus
 Presence_Mod_410

Presence Status
 Presence_Status_405

Enable Presence DI
 Enable_PresenceDI_412

Presence change to OCCUPIED (present):

If the BMS sets the **Presence Modbus** to 'present' or switches to 'present' via the **Presence key** on the unit, the **Presence Status** is set to 'present'.

The two inputs DI1 and DI2 can be configured as **presence contacts** using the **Input 1 Config** and **Input 2 Config** parameters.

To change the presence status via the digital inputs, you must set the **Enable Presence DI** to 'active'.

Presence change to UNOCCUPIED (absent):

If the **Presence Modbus** parameter and a digital input both signal 'absent', the **Presence Status** is set to 'absent'.

The **Presence key** on the unit can only switch the presence status to 'absent', if 'absent' is also signalled by the **Presence Modbus** and digital input.

Key enable when absent

Operation of the unit while the **Presence Status** parameter is set to 'absent' can be configured as follows using the **Presence Function** parameter:

1. Changing the presence status to 'present' via the Presence menu (default).
 It is possible to navigate through all menus, but setpoint adjustment is not possible.
2. Changing the presence status to 'present' by pressing any key.
 It is possible to navigate through all menus and adjust setpoints.
3. No status change possible, presence status remains 'present'.
 It is possible to navigate through all menus and adjust setpoints.

DIGITAL INPUT DI1 & DI2



Input 1 and input 2
may only be switched to
GND (potential-free)!

Applying voltage
to the two inputs will
destroy the unit!

[Configuration register](#)

[Input 1 Config](#)
Input1_Config_3900

[Input 2 Config](#)
Input2_Config_3901

[Data register](#)

[D1 Input Status](#)
D1Input_Status_126

[D2 Input Status](#)
D2Input_Status_127

[HeaderIconStatus_408](#)
HeaderIconStatus_...

[Header Icons Modbus](#)
HeaderIconModbus_411_bitField

[Enable Icons DI](#)
Enable_IconDI_413

7.0 Inputs, general information

The digital inputs **DI1** and **DI2** serve to detect a switching operation via a potential-free contact.





The type of digital inputs can be configured via the parameters **Input 1 Config** (DI1) and **Input 2 Config**. (DI2).



7.1 Inputs as presence contact

(see chapter 6.0 'Presence')

7.2 Inputs as contact for Header Icons

The icons in the header can be switched via the BMS (refer to chapter 2.1 'HMI layout') or via a configured DI input.

In normal operation, you can display the following **room climate** icons in parallel (Fig. 029):
Window contact  – Dew point  – Frost protection  – ECO mode 

In the event of a fault or active access via the USB-C interface, the following **status message** icons are **automatically** displayed (Fig. 030):
USB-C interface connected  – Fault / Alarm 

When a status message stops, the display automatically switches back to the configured room climate icons. The appearance and position of the header icons are permanently programmed into the unit and cannot be changed.



Fig. 029 Header - Room climate



Fig. 030 Header - Status messages

The configured icons can be shown or hidden using the **Header Icons Status** parameter. The register can be influenced in two ways:

- Via the **Header Icons Modbus** register
- Via the digital inputs **DI1** / **DI2**

HEADER ICONS

Logic

7.3 Header Icons Status

You can see how the Header Icons parameters influence each other in the following simplified illustration (Fig. 031):

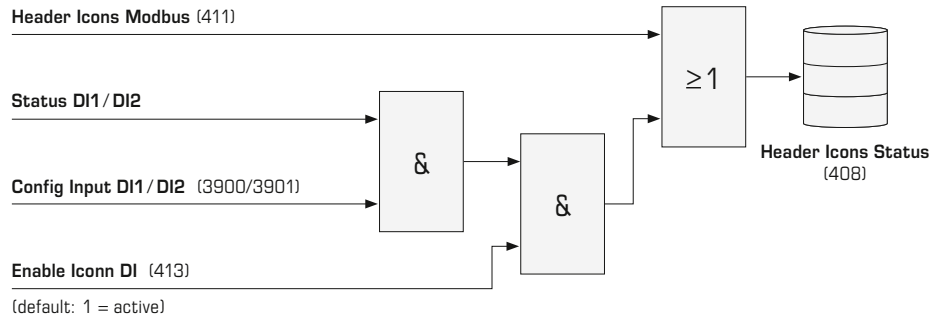

Fig. 031 Frost protection input / window / dew point / ECO

Icon	Input 1 Config Input1_Config_3900 Input 2 Config Input2_Config_3901	D1 Input Status D1Input_Status_126 D2 Input Status D2Input_Status_127	HeaderIconStatus_408_bitField depending on HeaderIconsModbus (411) Enable Icons DI (413) 1 = active → Icon shown
	13 = Frost protection NO contact	0 = open	depends on HeaderIconsModbus (411, Bit 0)
		1 = closed	1 = active → Frost protection icon shown
	14 = Frost protection NC contact	0 = open	1 = active → Frost protection icon shown
		1 = closed	depends on HeaderIconsModbus (411, Bit 0)
	3 = Window contact NO contact	0 = open	depends on HeaderIconsModbus (411, Bit 1)
		1 = closed	1 = active → Window contact icon shown
	4 = Window contact NC contact	0 = open	1 = active → Window contact icon shown
		1 = closed	depends on HeaderIconsModbus (411, Bit 1)
	5 = Dew point monitors NO contact	0 = open	depends on HeaderIconsModbus (411, Bit 2)
		1 = closed	1 = active → Dew point icon shown
	6 = Dew point monitors NC contact	0 = open	1 = active → Dew point icon shown
		1 = closed	depends on HeaderIconsModbus (411, Bit 2)
	15 = ECO NO contact	0 = open	depends on HeaderIconsModbus (411, Bit 3)
		1 = closed	1 = active → ECO Mode icon shown
	16 = ECO NC contact	0 = open	1 = active → ECO Mode icon shown
		1 = closed	depends on HeaderIconsModbus (411, Bit 3)
	11 = Alarm NO contact	0 = open	depends on HeaderIconsModbus (411, Bit 4)
		1 = closed	1 = active → Alarm/Fault icon shown
	12 = Alarm NC contact	0 = open	1 = active → Alarm/Fault icon shown
		1 = closed	depends on HeaderIconsModbus (411, Bit 4)

**TOUCH KEY
EXTENSION**

Configuration and ready-to-order variants for additional key pairs for light and sun protection (type-dependent)

8.0 Touch key extension, general information

In addition to the basic models (temperature/fan) there are also unit variants available with additional key pairs for **controlling the light and sun protection** (Fig. 032-037).

The unit type must be selected according to the desired light or sun protection circuits. It is not possible to make subsequent changes or additions to the **touch key assignment**.

The numbering of the light or sun protection circuits in the **Modbus register** is fixed and depends on the **code number** of the touch key extension (see table).

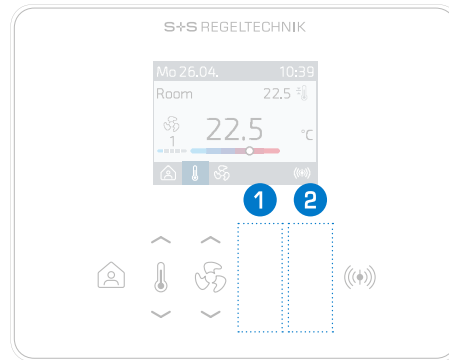

Fig. 032 Example Type 1401 (basic model)

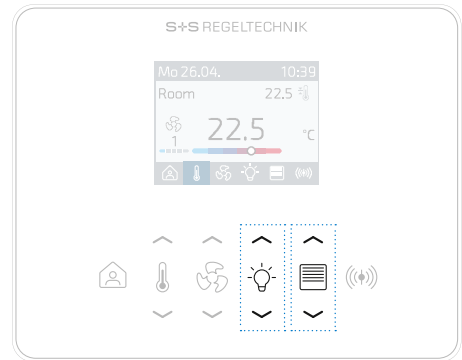

Fig. 033 Example Type 1401-LB

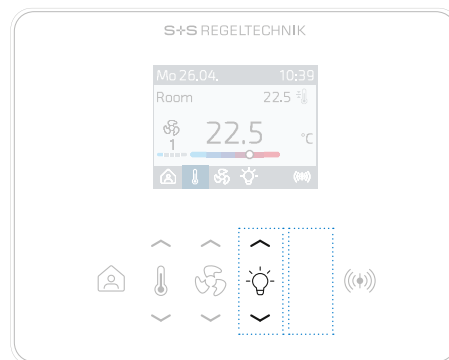

Fig. 034 Example Type 1401-L

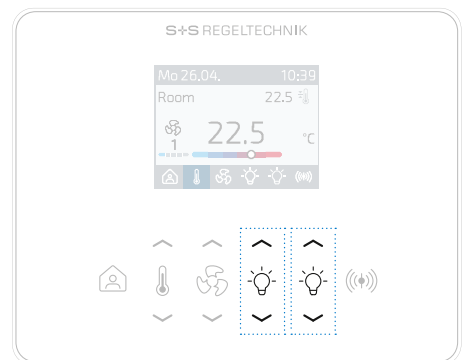

Fig. 035 Example Type 1401-LL

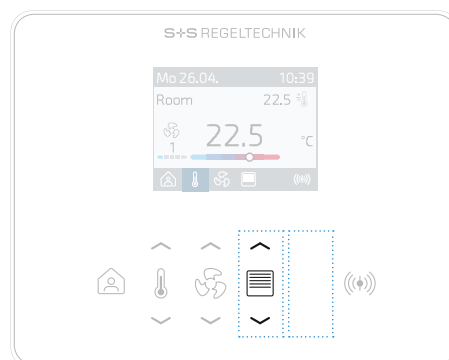

Fig. 036 Example Type 1401-B

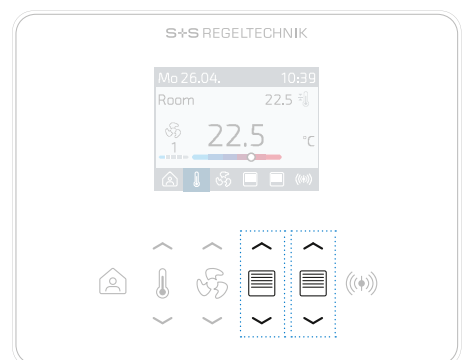
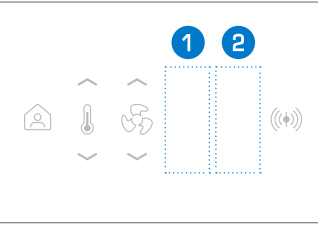
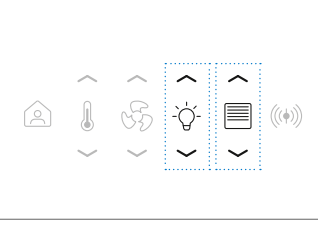
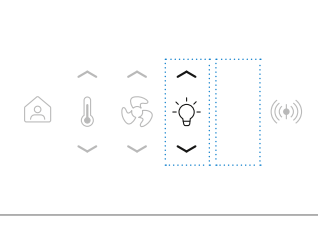
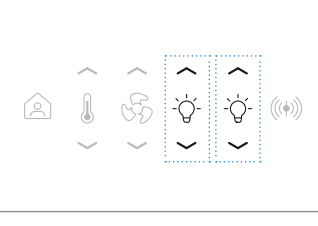



Fig. 037 Example Type 1401-BB

Assignment variants for additional key pairs (Printing on front face of unit)	Key extension		Ready-to-order variants for additional key pairs (Type labelling)
	1 Related linked data register	2 Related linked data register	
	(not assigned)	(not assigned)	Basic models without key extension Type 13xx (Temp.) Type 14xx (Temp.+Fan)
	Light 1 L_AutoMode_1100_bitField (bit0) L_LightStatus_1102_bitField (bit0) L1_KeyStatus_1120 L1_Dimm_Value_1121	Sun protect 2 SP_AutoMode_700_bitField (bit1) SP2_KeyStatus_730 SP2_Position_Value_731 SP2_Angle_Value_732	1x Light / 1x Sun protection (Blind) Key extension 1+2 Type 13xx-LB Type 14xx-LB
	Light 1 L_AutoMode_1100_bitField (bit0) L_LightStatus_1102_bitField (bit0) L1_KeyStatus_1120 L1_Dimm_Value_1121	(not assigned)	1x Light Key extension 1 Type 13xx-L Type 14xx-L
	Light 1 L_AutoMode_1100_bitField (bit0) L_LightStatus_1102_bitField (bit0) L1_KeyStatus_1120 L1_Dimm_Value_1121	Light 2 L_AutoMode_1100_bitField (bit1) L_LightStatus_1102_bitField (bit1) L2_KeyStatus_1130 L2_Dimm_Value_1131	2x Light Key extension 1+2 Type 13xx-LL Type 14xx-LL
	Sun protect 1 SP_AutoMode_700_bitField (bit0) SP1_KeyStatus_720 SP1_Position_Value_721 SP1_Angle_Value_722	(not assigned)	1x Sun protection (Blind) Key extension 1 Type 13xx-B Type 14xx-B
	Sun protect 1 SP_AutoMode_700_bitField (bit0) SP1_KeyStatus_720 SP1_Position_Value_721 SP1_Angle_Value_722	Sun protection 2 SP_AutoMode_700_bitField (bit1) SP2_KeyStatus_730 SP2_Position_Value_731 SP2_Angle_Value_732	2x Sun protection (Blind) Key extension 1+2 Type 13xx-BB Type 14xx-BB

Note:

Even if in the **1x Light / 1x Sun protection (LB)** variant, only one blind is controlled, the Modbus registers for **Sun protect 2** are valid. The numbering or labelling of the register is based on the **code number** of the touch key extension, i.e., **Light 1 / Sun protect 2**.

SUN PROTECTION (BLIND) CONTROL

Display and icons

Configuration register

Sun protect display
SP_Display_4201

Data register

Sun protect auto mode
SP_AutoMode_700_bitField

8.1 Sun Protect menu (sun protection adjustment)

The **Sun Protect menu** is only available for unit types **with** sun protection adjustment. The user can adjust the sun protection manually (Manual mode) using the **UP** and **DOWN** arrow keys next to the **SUN PROTECTION** icon (Fig. 038).

The BMS can use the **Sun protect auto mode** parameter to temporarily block manual adjustment (Manual mode) for the user. When locking is active, the adjustment is carried out exclusively by the BMS. This locking is shown on the display as **Automatic mode** .

The Sun Protect menu can be permanently disabled via the **Sun protect display** parameter. The operator can continue to control the sun protection by visual orientation using the corresponding arrow keys. The display remains unchanged in the process (e.g. in the Temp menu).

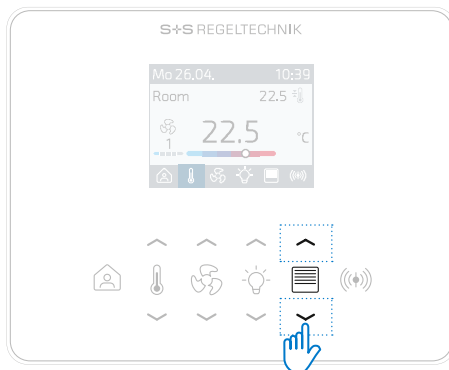

Fig. 038 Sun protection adjustment via arrow keys

Display

In the Sun Protect menu, it is possible to display the position (Up/Down) and the slat angle (turned left - horizontal - turned right), operating statuses (Auto) and labels (Fig. 039). The display is configured via the Modbus register.

LABELLING

Labels (default) are individually configurable (can be set via Modbus)

Note: Adjustments are made **using the arrow keys** (touch keys) in the keypad.

Manual adjustment (manual mode) blocked by BMS.
A = **Automatic mode**

The examples below show sun protection adjustment in **two zones (BB) = 1/2**

POSITION UP/DOWN TURNING ANGLE

POSITION UP/DOWN

The status line bar visualises the **sun protection position** between **0%** (fully open) and **100%** (fully closed).

Sun Protect Position value (can be set via Modbus)

Min. position:	0 %
Max. position:	100 %
Step size:	0.5 %

SUN PROTECT ANGLE VALUE (can be set via Modbus)

Max. left rotation:	-80°
Max. right rotation:	80°
Step size:	10°

Fig. 039 Sun Protect menu elements

SUN PROTECTION (BLIND) CONTROL

Configuration and adjustment

[Configuration register](#)

Sun Protect Label

SP1_Label_4250-4261
SP2_Label_4300-4311

Sun Protect Type

SP1_Type_4264
SP2_Type_4314

Sun Protect OpMode

SP1_OpMode_4263
SP2_OpMode_4313

[Data register](#)

Sun Protect Key Status

SP1_KeyStatus_720
SP2_KeyStatus_730

Sun Protect Position Value

SP1_Position_Value_721
SP2_Position_Value_731

Sun Protect Angle Value

SP1_Angle_Value_722
SP2_Angle_Value_732

[Configuration register](#)

Sun Protect Position Step Size

SP1_PositionStepSize_4265
SP2_PositionStepSize_4315

Sun Protect Position Min

SP1_PositionMin_4267
SP2_PositionMin_4317

Sun Protect Position Max

SP1_PositionMax_4268
SP2_PositionMax_4318

[Configuration register](#)

Sun Protect Angle Step Size

SP1_AngleStepSize_4266
SP2_AngleStepSize_4316

Sun Protect Angle Min

SP1_AngleMin_4269
SP2_AngleMin_4319

Sun Protect Angle Max

SP1_AngleMax_4270
SP2_AngleMax_4320

Labelling

Default labels are predefined in each language for sun protection.

Irrespective of this, each label can be changed individually using the **Sun Protect Label** parameter. You can use a maximum of 12 characters for this.

Sun protection types

The following variants can be selected via the **Sun Protect Type** parameter:

- **Sun Protect Position** (up/down)
- **Sun Protect Slat Angle** (slat rotation)
- **Sun Protect Position + Slat Angle** (default)

The position of the sun protection can be written using the **Sun Protect Position Value** parameter, and for the slat angle of the slats using the **Sun Protect Angle Value** parameter. Writing is performed either by the BMS or by the user in 'Default' operating mode (see description for sun protection adjustment in 'Default' operating mode).

Operating mode and key status





The following variants can be configured via the **Sun Protect OpMode** parameter:

- **'Short-long key press'** for fast bus line (default)
In the data register **Sun Protect Key Status**, a short (< 1 s) or long (> 1 s) key press is recorded. After reading, the BMS writes back the value **'not pressed'**.
The BMS writes the position and angle back to the data register **Sun Protect Position Value** and **Sun Protect Angle Value**. The GUI is adjusted.
- **'Hold key press'** for fast bus line (default)
The key press is registered in the data register **Sun Protect Key Status**, until the user releases the key. After the key is released, the unit resets the value back to **'not pressed'**.
The BMS writes the position and angle back to the data register **Sun Protect Position Value** and **Sun Protect Angle Value**. The GUI is adjusted.
- **'Setpoint mode'**
If the user presses one of the two keys, the position and angle are written directly to the registers **Sun Protect Position Value** and **Sun Protect Angle Value**. The GUI is adjusted.
The BMS retrieves the values as a default.
For the relationship between pressing the key and adjusting the position and angle, please refer to the description for sun protection adjustment in the 'Setpoint mode' operating mode provided below.





Sun protection adjustment in 'Setpoint mode' operating mode (Manual mode)

The user makes the adjustment using the arrow keys (touch keys) as follows:

Position (up/down)

- Short key press **UP**  (< 1 s) reduces the **Sun Protect Position Value** by the set **Sun Protect Position Step Size** (default: 0.5 %)
- Short key press **DOWN**  (< 1 s) increases the **Sun Protect Position Value** by the set **Sun Protect Position Step Size** (default: 0.5 %)
- Long key press **UP**  (> 1 s) reduces the value automatically depending on the set step size, until one of the two arrow keys is pressed again or **Sun Protect Position Min** is reached (default: 0 %, complete light incidence).
- Long key press **DOWN**  (> 1 s) increases the value automatically depending on the set step size, until one of the two arrow keys is pressed again or **Sun Protect Position Max** is reached (default: 100 %, no light incidence).

Slat angle (slat rotation)

- Short key press **UP**  (< 1 s) reduces the **Sun Protect Angle Value** by the set **Sun Protect Angle Step Size** (default: 10°)
- Short key press **DOWN**  (< 1 s) increases the **Sun Protect Angle Value** by the set **Sun Protect Angle Step Size** (default: 10°)
- Long key press **UP**  (> 1 s) reduces the value automatically depending on the set step size, until one of the two arrow keys is pressed again or **Sun Protect Angle Min** is reached (default: 0°).
- Long key press **DOWN**  (> 1 s) increases the value automatically depending on the set step size, until one of the two arrow keys is pressed again or **Sun Protect Angle Max** is reached (default: 80°).

LIGHTS CONTROL

Display and icons

Configuration register

Light display
L_Display_5301

Data register

Light auto mode
L_AutoMode_1100_bitField

8.2 Light menu (light adjustment)

The **Light menu** is only available for unit types **with** light adjustment.

The user can adjust the light manually (Manual mode) using the **UP** and **DOWN** arrow keys next to the **Light** icon (Fig. 040).

The BMS can use the **Light auto mode** parameter to temporarily block manual adjustment (Manual mode) for the user. This locking is shown on the display as **Automatic mode** **A**.

The Light menu can be permanently disabled via the **Light display** parameter. The operator can continue to control the room lighting by visual orientation using the corresponding arrow keys.

The display remains unchanged in the process (e.g. in the Temp menu).

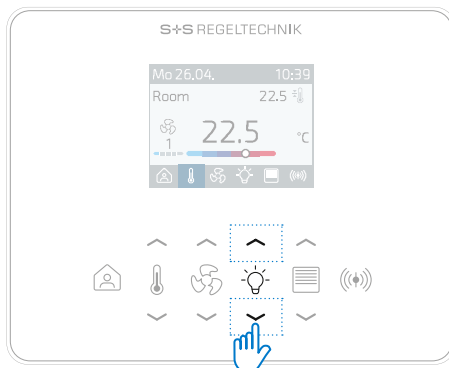

Fig. 040 Light adjustment via arrow keys

Display

In the Light menu, it is possible to display all statuses (Off/On, Dimming value 0...100 %), operating statuses (Auto) and labels (Fig. 041).

The display is configured via the Modbus register.

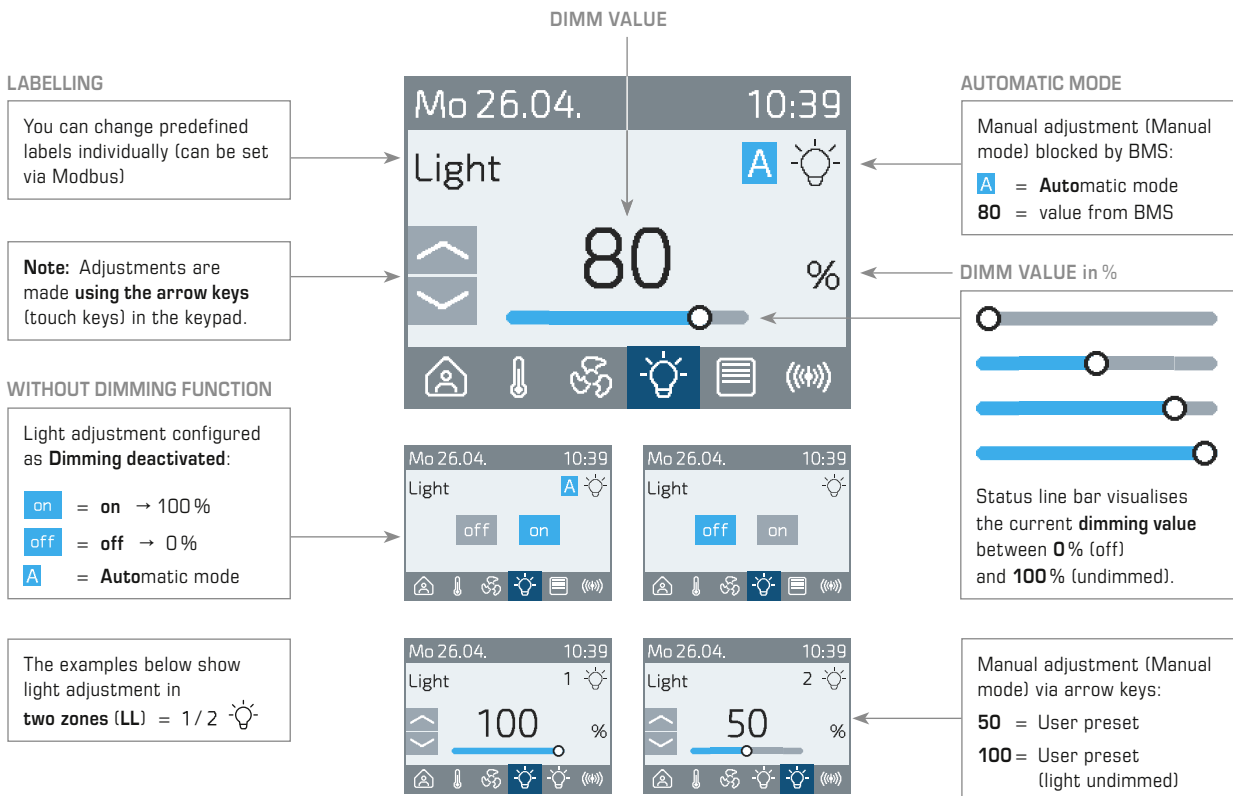

Fig. 041 Elements in the Light menu

LIGHTS CONTROL

Configuration and adjustment

[Configuration register](#)

Light Label

L1_Label_5350-5361
L2_Label_5400-5411

Light Dimmable

L1_Dimmable_5363
L2_Dimmable_5413

Light OpMode

L1_OpMode_5364
L2_OpMode_5414

[Data register](#)

Light Key Status

L1_KeyStatus_1120
L2_KeyStatus_1130

Light Dimm Value

L1_Dimm_Value_1121
L2_Dimm_Value_1131

Light Status

L_LightStatus_1102_bitField

Labelling

Default labels are predefined in each language for the light.

Irrespective of this, each label can be changed individually using the **Light Label** parameter. You can use a maximum of 12 characters for this.

Light types and statuses

The following light types can be selected via the **Light Dimmable** parameter:

- **Light dimming deactivated** (off: 0 % / On: 100 %)
- **Light dimming activated** (Dimming value: 0...100 %) (default)

The dimming value is written via the **Light Dimm Value** parameter.

Writing is performed either by the BMS or by the user in 'Setpoint mode' operating mode (see description for light adjustment in 'Setpoint mode' operating mode).

The **Light Status** parameter is mapped to the coil register and linked with the holding parameter **Light Dimm Value**:

- **Dimm Value = 0 %** (by the user or BMS) → bit in **Light Status** to 0
- **Dimm Value > 0 %** (by the user or BMS) → bit in **Light Status** to 1

The **Light Status** parameter (coil mapping) lets you switch on or off all lights with a bit change (0/1). The **Dimm Value** is thereby set to 0 % or 100 %.

Note: The unit does not keep the previous value.

Example 1

Light 1 has the dimming value of 50 % (dimmed). This gives the following parameter entries as a result:

Light 1 Dimm Value = 50, **Light Status** bit 0 = 1 (coil mapping)

The BMS now switches to **Light Status** (bit 0) or from 1 to 0 in the corresponding coil register.

The **Light Dimm Value** parameter follows automatically and has the final value of 0.

Example 2

Light 1 has the dimming value of 0 % (light Off). This gives the following parameter entries as a result:

Light 1 Dimm Value = 0, **Light Status** bit 0 = 0 (coil mapping)

The BMS now switches to **Light Status** (bit 0) or from 0 to 1 in the corresponding coil register.

The **Light Dimm Value** parameter follows automatically and has the final value of 100.

Operating mode and key status

The following variants can be configured via the **Light OpMode** parameter:

- **Short-long key** (default)

In the data register **Light Key Status**, a short (< 1 s) or long (> 1 s) key press is recorded. After reading, the BMS writes back the value 'not pressed'.

The BMS writes the dimming value to the **Light Dimm Value** data register. The GUI is adjusted.

- **Hold key press**

The key press is registered in the data register **Light Key Status** until the user releases the key. After the key is released, the unit resets the value back to 'not pressed'.

The BMS writes the dimming value to the **Light Dimm Value** data register. The GUI is adjusted.

- **Setpoint mode**

If the user presses one of the two keys, the Dimm value is written directly to the data register **Light Dimm Value**. The GUI is adjusted. The BMS retrieves the values as a default.

For the relationship between pressing the key and adjusting the Dimm value, please refer to the description for sun protection adjustment in 'Setpoint mode' operating mode provided below.

Light adjustment in 'Setpoint mode' operating mode (Manual mode)

The user makes the adjustment using the arrow keys (touch keys) as follows:

Light dimming activated (Dimm value: 0...100 %)

- Short key press **UP** ⬆ (< 1 s) increases the **Light Dimm Value** by the set **Light Dimm Step Size** (default: 10 %)
- Short key press **DOWN** ⬇ (< 1 s) reduces the **Light Dimm Value** by the set **Light Dimm Step Size** (default: 10 %)
- Long key press **UP** ⬆ (> 1 s) sets the value automatically to 100 %.
- Short key press **DOWN** ⬇ (> 1 s) sets the value automatically to 0 %.

Light dimming deactivated (off: 0 % / on: 100 %)

Pressing the **UP** ⬆ or **DOWN** ⬇ key (irrespective of the key press duration) sets the value to 0 % (off) or 100 % (on) in the data register **Light Dimm Value**.

[Configuration register](#)

Light Dimm Step Size

L1_DimmStepSize_5368
L2_DimmStepSize_5418



© Copyright by S+S Regeltechnik GmbH

Reprint in full or in parts requires permission from S+S Regeltechnik GmbH.

Subject to errors and technical changes. All statements and data herein represent our best knowledge at date of publication. They are only meant to inform about our products and their application potential, but do not imply any warranty as to certain product characteristics. Since the devices are used under a wide range of different conditions and loads beyond our control, their particular suitability must be verified by each customer and/or end user themselves. Existing property rights must be observed. We warrant the faultless quality of our products as stated in our General Terms and Conditions.

